

Technical Information

Proline Prowirl F 200

Vortex flowmeter



The flowmeter with detection of wet steam conditions, available as compact or remote version

Application

- Preferred measuring principle for wet/saturated/superheated steam, gases & liquids (also cryogenic)
- Suitable for a wide range of applications; optimized for steam applications

Device properties

- Wet steam detection for DN 25 to 100 (1 to 4")
- Inlet run compensation
- Installation length according to industry standard
- Display module with data transfer function
- Robust two-chamber housing
- Plant safety: worldwide approvals (SIL, Haz. area)

Your benefits

- Integrated temperature measurement for mass/energy flow of saturated steam
- Highest process safety – dualsens version enables redundant measurement
- High availability – proven robustness, resistance to vibrations, temperature shocks & water hammer
- No maintenance – lifetime calibration
- Convenient device wiring – separate connection compartment
- Safe operation – no need to open the device due to display with touch control, background lighting
- Integrated verification – Heartbeat Technology™







Table of contents

Document information	3	Electromagnetic compatibility (EMC)	60
Symbols used	3		
Function and system design	4	Process	60
Measuring principle	4	Medium temperature range	60
Measuring system	7	Pressure-temperature ratings	60
		Pressure loss	62
Input	7	Thermal insulation	63
Measured variable	7	Vibrations	63
Measuring range	13		
Operable flow range	13	Mechanical construction	63
Input signal	13	Design, dimensions	63
		Weight	77
Output	14	Materials	81
Output signal	14	Process connections	84
Signal on alarm	16		
Load	17	Operability	84
Ex connection data	17	Operating concept	84
Low flow cut off	22	Local operation	84
Galvanic isolation	23	Remote operation	85
Protocol-specific data	23	Service interface	87
Power supply	29	Certificates and approvals	87
Terminal assignment	29	CE mark	87
Pin assignment, device plug	31	C-Tick symbol	88
Supply voltage	31	Ex approval	88
Power consumption	32	Functional safety	90
Current consumption	32	FOUNDATION Fieldbus certification	90
Power supply failure	32	Certification PROFIBUS	90
Electrical connection	33	Pressure Equipment Directive	90
Potential equalization	38	Other standards and guidelines	90
Terminals	38		
Cable entries	38	Ordering information	91
Cable specification	38		
Overvoltage protection	39	Application packages	91
		Diagnostics functions	91
Performance characteristics	40	Heartbeat Technology	91
Reference operating conditions	40	Air and industrial gases	92
Maximum measured error	40	Wet steam detection	92
Repeatability	42	Natural gas	92
Response time	42		
Influence of ambient temperature	42	Accessories	92
		Device-specific accessories	92
Installation	43	Communication-specific accessories	93
Mounting location	43	Service-specific accessories	94
Orientation	43	System components	95
Inlet and outlet runs	44		
Length of connecting cable	46	Supplementary documentation	95
Installing the wall-mount housing	47	Standard documentation	95
Special mounting instructions	48	Supplementary device-dependent documentation	95
Environment	48	Registered trademarks	96
Ambient temperature range	48		
Storage temperature	59		
Climate class	59		
Degree of protection	60		
Vibration resistance	60		









Document information

Symbols used

Electrical symbols



Symbol	Meaning
	Direct current A terminal to which DC voltage is applied or through which direct current flows.
	Alternating current A terminal to which alternating voltage is applied or through which alternating current flows.
	Direct current and alternating current <ul style="list-style-type: none"> ▪ A terminal to which alternating voltage or DC voltage is applied. ▪ A terminal through which alternating current or direct current flows.
	Ground connection A grounded terminal which, as far as the operator is concerned, is grounded via a grounding system.
	Protective ground connection A terminal which must be connected to ground prior to establishing any other connections.
	Equipotential connection A connection that has to be connected to the plant grounding system: This may be a potential equalization line or a star grounding system depending on national or company codes of practice.

Symbols for certain types of information

Symbol	Meaning
	Permitted Indicates procedures, processes or actions that are permitted.
	Preferred Indicates procedures, processes or actions that are preferred.
	Forbidden Indicates procedures, processes or actions that are forbidden.
	Tip Indicates additional information.
	Reference to documentation Refers to the corresponding device documentation.
	Reference to page Refers to the corresponding page number.
	Reference to graphic Refers to the corresponding graphic number and page number.
	Visual inspection

Symbols in graphics

Symbol	Meaning
1, 2, 3,...	Item numbers
1., 2., 3.,...	Series of steps
A, B, C, ...	Views
A-A, B-B, C-C, ...	Sections
 A0013441	Flow direction

Symbol	Meaning
 A0011187	Hazardous area Indicates a hazardous area.
 A0011188	Safe area (non-hazardous area) Indicates the non-hazardous area.

Function and system design

Measuring principle

Vortex meters work on the principle of the *Karman vortex street*. When fluid flows past a bluff body, vortices are alternately formed on both sides with opposite directions of rotation. These vortices each generate a local low pressure. The pressure fluctuations are recorded by the sensor and converted to electrical pulses. The vortices develop very regularly within the permitted application limits of the device. Therefore, the frequency of vortex shedding is proportional to the volume flow.

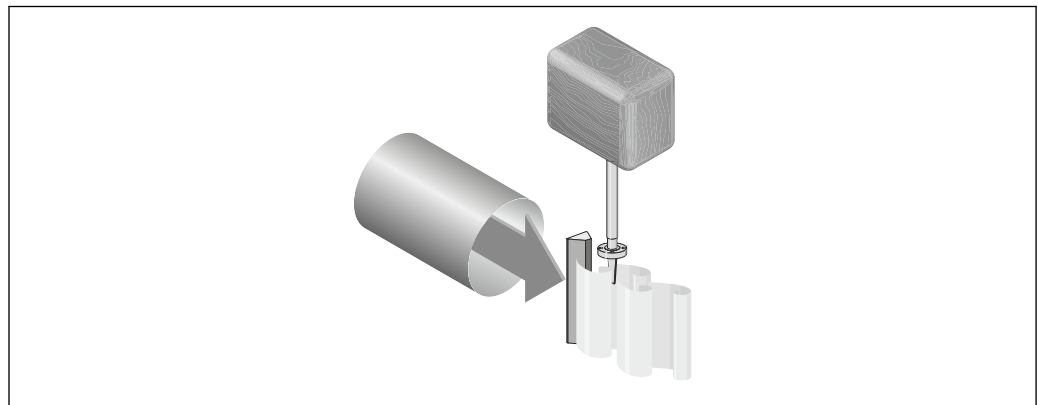

A0019373

The calibration factor (K-factor) is used as the proportional constant:

$$\text{K-Factor} = \frac{\text{Pulses}}{\text{Unit Volume [m}^3\text{]}}$$

A0003939-EN

Within the application limits of the device, the K-factor only depends on the geometry of the device. For $Re > 20\,000$ it is:

- Independent of the flow velocity and the fluid properties viscosity and density
- Independent of the type of substance under measurement: steam, gas or liquid

The primary measuring signal is linear to the flow. After production, the K-factor is determined in the factory by means of calibration. It is not subject to long-time drift or zero-point drift.

The device does not contain any moving parts and does not require any maintenance.

The capacitance sensor

The sensor of a vortex flowmeter has a major influence on the performance, robustness and reliability of the entire measuring system.

The robust DSC sensor is:

- burst-tested
- tested against vibrations
- tested against thermal shock (thermal shocks of 150 K/s)

The Prowirl uses the tried-and-tested capacitance measuring technology of Endress+Hauser applied in over 300 000 measuring points worldwide.

The DSC (differential switched capacitance) sensor patented by Endress+Hauser has complete mechanical balancing. It only reacts to the measured variable (vortex) and does not react to

vibrations. Even in the event of pipe vibrations, the smallest of flows can be reliably measured at low density thanks to the unimpaired sensitivity of the sensor. Thus, the wide turndown is also maintained even in the event of harsh operating conditions. Vibrations up to 1 g at least, at frequencies up to 500 Hz in every axis (X, Y, Z), do not affect the flow measurement. Thanks to its design, the capacitance sensor is also particularly mechanically resistant to temperature shocks and pressure shocks in steam pipelines.

Temperature measurement

Under the "Sensor version" order code the "Mass flow" option is available (→ 5). With this option the measuring device can also measure the temperature of the medium.

The temperature is measured via Pt 1000 temperature sensors. These sensors are located in the paddle of the DSC sensor and are therefore in the direct vicinity of the fluid.

Order code for "Sensor version":

- Option 1 "Volume flow, basis"
- Option 2 "Volume flow, high-temperature/low temperature"
- Option 3 "Mass flow (integrated temperature measurement)"

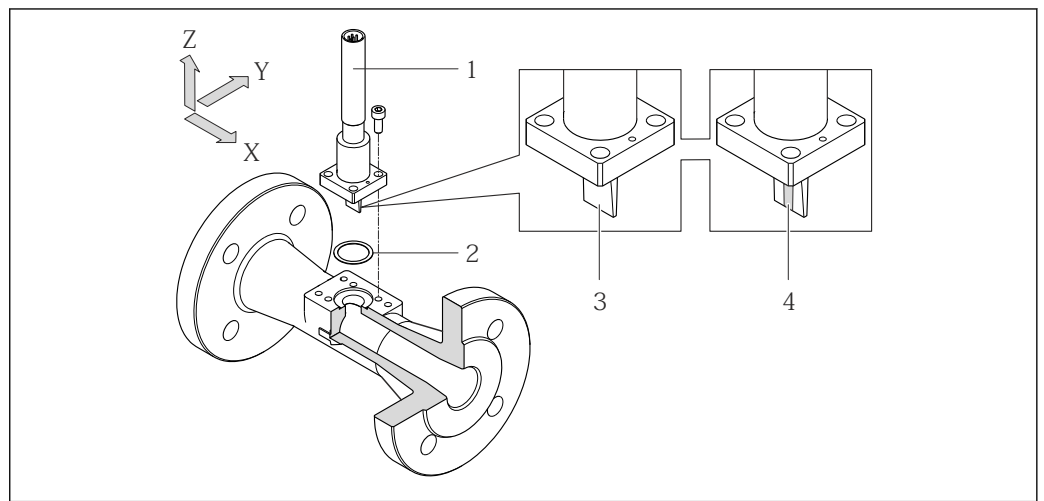

1 Sample graphic

- 1 Sensor
- 2 Seal
- 3 Order code for "Sensor version", option 1 "Volume flow, basis" and option 2 "Volume flow, high-temperature/low-temperature"
- 4 Order code for "Sensor version", option 3 "Mass flow (integrated temperature measurement)"

Lifelong calibration

Experience has shown that recalibrated Prowirl devices demonstrate a very high degree of stability compared to their original calibration: The recalibration values were all within the original measuring accuracy specifications of the devices.

Various tests and simulation procedures carried out on devices by filing away the edges of Prowirl's bluff body found that there was no negative impact on the accuracy up to a rounding diameter of 1 mm (0.04 in).

If the meter's edges do not show rounding at the edges that exceeds 1 mm (0.04 in), the following general statements apply (for non-abrasive and non-corrosive media, such as in most water and steam applications):

- The measuring device does not display an offset in the calibration and the accuracy is still guaranteed.
- All the edges on the bluff body have a radius that is typically smaller in size. As the measuring devices are naturally also calibrated with these radii, the measuring device remains within the specified accuracy rating provided that the additional radius that is produced as a result of wear and tear does not exceed 1 mm (0.04 in).

Consequently it can be said that the Prowirl product line offers lifelong calibration if the measuring device is used in non-abrasive and non-corrosive media.

Inlet run correction

Inlet run correction makes it possible to shorten the necessary inlet run before the measuring device to a minimum length of $10 \times \text{DN}$. If the inlet run available is too short, the measuring device can correct the measured error depending on the preceding disruption in the flow profile. This results in an additional measuring uncertainty of $\pm 0.5\%$ o.r.

The **Inlet Run Correction** function can be used for the following pressure ratings and nominal diameters:

DN 15 to 150 (1 to 6")

- EN (DIN)
- ASME B16.5, Sch. 40/80

Inlet run correction is possible for the following flow obstructions:

- Single elbow (90° elbow)
- Double elbow (2 × 90° elbows, opposite)
- Double elbow 3D (2 × 90° elbows, opposite, not in one plane)
- Reduction by one nominal diameter size



Inlet and outlet runs to be considered (→ 44)



For detailed information about inlet run correction, see the Special Documentation for the device (→ 95)

Wet steam detection

The mass flow option for Prowirl 200 is optionally available with a "Wet steam detection" application package.

Using patented signal analysis this enables the detection of condensate in steam (known as wet steam).

Wet steam can be caused by:

- Frothing in the steam boiler
- Heat loss in the steam pipe
- Malfunction of equipment (e.g. steam traps) in the steam pipe

This wet steam reduces efficiency and could potentially cause safety issues.

Using the "Wet steam detection" application package, the flow computer can determine additional secondary measured variables from the primary measured variables recorded.

Wet steam alarm

With wet steam detection, the measuring device can trigger a wet steam alarm if the steam quality drops below 80%.



For detailed information about wet steam detection, see the Special Documentation for the device (→ 95)

Diagnostic functions

In addition, the device offers extensive diagnostic options, such as tracking fluid and ambient temperatures, extreme flows etc.

Minimum and maximum values:

- Frequency
- Temperature
- Velocity
- Pressure

Measuring system

The device consists of a transmitter and a sensor.

Two device versions are available:

- Compact version - the transmitter and sensor form a mechanical unit.
- Remote version – the transmitter and sensor are mounted separately from one another.

Transmitter

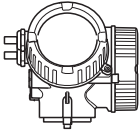
<p>Prowirl 200</p>  <p style="text-align: right; font-size: small;">A0013471</p>	<p>Device versions and materials:</p> <ul style="list-style-type: none"> ■ Compact or remote version, aluminum coated: Aluminum, AlSi10Mg, coated ■ Compact or remote version, stainless: For maximum corrosion resistance: stainless steel 1.4404 (316L) <p>Configuration:</p> <ul style="list-style-type: none"> ■ Via four-line local display with key operation or via four-line, illuminated local display with touch control and guided menus ("Make-it-run" wizards) for applications ■ Via operating tools (e.g. FieldCare)
--	---

Sensor

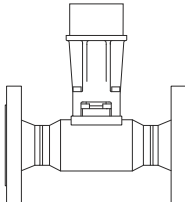
<p>Prowirl F</p>  <p style="text-align: right; font-size: small;">A0009921</p>	<p>Flanged version:</p> <ul style="list-style-type: none"> ■ Nominal diameter range: DN 15 to 300 (½ to 12") ■ Materials: <ul style="list-style-type: none"> - Measuring tubes: stainless steel, 1.4408 (CF3M) - Process connections DN 15 to 150 (½ to 6"): stainless steel, 1.4404 (F316, F316L) - Fully cast construction for DN 200 to 300 (8 to 12"): stainless cast steel, 1.4408 (CF3M) - Version for "harsh process, wetted parts": cast alloy CX2MW similar to Alloy C22/2.4602
---	---

Input

Measured variable

Direct measured variables

Order code for "Sensor version":

- Option 1 "Volume flow, basis" and
- Option 2 "Volume flow, high-temperature/low temperature":
Volume flow

Order code for "Sensor version":

- Option 3 "Mass flow (integrated temperature measurement)":
 - Volume flow
 - Temperature

Calculated measured variables

Order code for "Sensor version":

- Option 1 "Volume flow, basis" and
- Option 2 "Volume flow, high-temperature/low temperature":
 - In the case of constant process conditions: Mass flow ¹⁾ or Corrected volume flow
 - The totalized values for Volume flow, Mass flow ¹⁾, or Corrected volume flow

1) A fixed density must be entered for calculating the mass flow (Setup menu → Advanced setup submenu → External compensation submenu → Fixed density parameter).

Order code for "Sensor version":

Option 3 "Mass flow (integrated temperature measurement)":

- Mass flow
- Corrected volume flow
- Energy flow
- Heat flow difference
- Calculated saturated steam pressure

Calculation of the measured variables

The meter electronics system of the Prowirl 200 unit with the order code "Sensor version", option 3 "Mass flow (integrated temperature measurement)" has a flow computer. This computer can calculate the following secondary measured variables directly from the primary measured variables recorded using the pressure value (entered or external) and/or temperature value (measured or entered).

Mass flow and corrected volume flow

Medium	Fluid	Standards	Explanation
Steam ¹⁾	Superheated steam ²⁾	IAPWS-IF97/ ASME	If the device features integrated temperature measurement and in the event of constant pressure, or if the pressure is read in via the current input/HART/PROFIBUS PA/ FOUNDATION Fieldbus
	Saturated steam		Possible with integrated temperature measurement
	Wet steam ³⁾		Steam with steam quality < 100 %
Gas	Single gas	NEL40	In the event of constant pressure, or if the pressure is read in via the current input/HART/PROFIBUS PA/FOUNDATION Fieldbus
	Gas mixture	NEL40	
	Air	NEL40	
	Natural gas	ISO 12213-2	Contains AGA8-DC92 In the event of constant pressure, or if the pressure is read in via the current input/HART/PROFIBUS PA/FOUNDATION Fieldbus
		AGA NX-19	In the event of constant pressure, or if the pressure is read in via the current input/HART/PROFIBUS PA/FOUNDATION Fieldbus
		ISO 12213-3	Contains SGERG-88, AGA8 Gross Method 1 In the event of constant pressure, or if the pressure is read in via the current input/HART/PROFIBUS PA/FOUNDATION Fieldbus
Other gases	Linear equation	Ideal gases In the event of constant pressure, or if the pressure is read in via the current input/HART/PROFIBUS PA/FOUNDATION Fieldbus	
Liquids	Water	IAPWS-IF97/ ASME	
	Liquefied gas	Tables	Propane and butane mixture
	Other liquid	Linear equation	Ideal liquids

- 1) The calculated values (mass flow, corrected volume flow) refer to the specific steam states for which the measuring device has been programmed (superheated steam, saturated steam or wet steam).
- 2) A warning is displayed if the steam state approaches the saturation line (2K; Diagnostic No. 871).
- 3) A warning is displayed if the steam quality drops below 80 % (Diagnostic No. 872).

Mass flow calculation

Volume flow × operating density

- Operating density for saturated steam, water and other liquids: depends on the temperature
- Operating density for superheated steam and all other gases: depends on the temperature and pressure

Corrected volume flow calculation

(Volume flow × operating density)/reference density

- Operating density for water and other liquids: depends on the temperature
- Operating density for all other gases: depends on the temperature and pressure

Energy flow

Medium	Fluid	Standards	Explanation	Heat/energy option
Steam ¹⁾	Superheated steam ²⁾	IAPWS-IF97/ASME	In the event of constant pressure, or if the pressure is read in via the current input/HART/PROFIBUS PA/FOUNDATION Fieldbus	Heat Gross calorific value ³⁾ in relation to mass Net calorific value ⁴⁾ in relation to mass Gross calorific value ³⁾ in relation to corrected volume Net calorific value ⁴⁾ in relation to corrected volume
	Saturated steam			
	Wet steam ⁵⁾			
Gas	Single gas	ISO 6976	Contains GPA 2172 In the event of constant pressure, or if the pressure is read in via the current input/HART/PROFIBUS PA/FOUNDATION Fieldbus	
	Gas mixture		Contains GPA 2172 In the event of constant pressure, or if the pressure is read in via the current input/HART/PROFIBUS PA/FOUNDATION Fieldbus	
	Air	NEL40	In the event of constant pressure, or if the pressure is read in via the current input/HART/PROFIBUS PA/FOUNDATION Fieldbus	
	Natural gas	ISO 6976	Contains GPA 2172 In the event of constant pressure, or if the pressure is read in via the current input/HART/PROFIBUS PA/FOUNDATION Fieldbus	
			AGA 5	
Liquids	Water	IAPWS-IF97/ASME		
	Liquefied gas	ISO 6976	Contains GPA 2172	
	Other liquid	Linear equation		

- 1) The calculated values (mass flow, corrected volume flow) refer to the specific steam states for which the measuring device has been programmed (superheated steam, saturated steam or wet steam).
- 2) A warning is displayed if the steam state approaches the saturation line (2K; Diagnostic No. 871).
- 3) Gross calorific value: combustion energy + condensation energy of the flue gas (gross calorific value > net calorific value)
- 4) Net calorific value: only combustion energy
- 5) A warning is displayed if the steam quality drops below 80 % (Diagnostic No. 872).

Mass flow and energy flow calculation



NOTICE

The process pressure (p) in the process pipe is required to calculate the process variables and the limit values of the measuring range.

- ▶ In the case of the HART device, the process pressure can be read in from an external transmitter (e.g. Cerabar-M) via the 4 to 20mA current input or via HART or entered as a fixed value in the **External compensation** submenu .
- ▶ In the case of the PROFIBUS PA device, the process pressure can be transmitted from the Profibus master to the measuring device via the AO Block or entered as a fixed value in the **External compensation** submenu .
- ▶ In the case of the FOUNDATION Fieldbus device, the process pressure can be read in from an external pressure transmitter (e.g. Cerabar-M) via the MAO Block or entered as a fixed value in the **External compensation** submenu .

The calculation is performed based on the following factors:

- Assuming superheated steam conditions the measuring device calculates until the saturation point is reached. Approaching 2 K above saturation, the diagnostic message **△S871 Near steam saturation limit** is triggered . The warning can be redefined as an alarm or can also be disabled .
- If the temperature continues to drop, assuming saturated steam conditions the measuring device continues measuring up to a temperature of 0 °C (+32 °F). If pressure is the preferred measured variable, the **Saturated steam** option must be selected in the **Select steam type** parameter and the **Pressure** option must be selected in the **Saturated steam calculation mode** parameter (**Expert** menu → **Sensor** submenu → **Measurement mode** submenu → **Saturated steam calculation mode** parameter).

 Detailed information on external compensation is provided in the Operating Instructions for the device(→  95)

Calculated value

The unit calculates the mass flow, heat flow, energy flow, density and specific enthalpy from the measured volume flow and the measured temperature and/or the pressure based on international standard IAPWS-IF97 (ASME steam data).

Formulae for calculation:

- Mass flow: $m = q \cdot \rho (T, p)$
- Heat quantity: $E = q \cdot \rho (T, p) \cdot h_D (T, p)$

m = Mass flow

E = Heat quantity

q = Volume flow (measured)

h_D = Specific enthalpy

T = Operating temperature (measured)

p = Process pressure

ρ = Density²⁾

Pre-programmed gases

The following gases are pre-programmed in the flow computer:

Hydrogen ¹⁾	Helium 4	Neon	Argon
Krypton	Xenon	Nitrogen	Oxygen
Chlorine	Ammonia	Carbon monoxide ¹⁾	Carbon dioxide
Sulfur dioxide	Hydrogen sulfide ¹⁾	Hydrogen chloride	Methane ¹⁾
Ethane ¹⁾	Propane ¹⁾	Butane ¹⁾	Ethylene (ethene) ¹⁾
Vinyl chloride	Mixtures of up to 8 components of these gases ¹⁾		

1) The energy flow is calculated as per ISO 6976 (contains GPA 2172) or AGA5 - in relation to the net calorific value or gross calorific value .

2) From steam data as per IAPWS-IF97 (ASME), for the measured temperature and the specified pressure

Energy flow calculation

Volume flow × operating density × specific enthalpy

- Operating density for saturated steam and water: depends on the temperature
- Operating density for superheated steam, natural gas ISO 6976 (contains GPA 2172), natural gas AGA5: depends on the temperature and pressure

Heat flow difference

- Between saturated steam upstream from a heat exchanger and condensate downstream from the heat exchanger (second temperature read in via current input/HART/PROFIBUS PA/FOUNDATION Fieldbus) in accordance with IAPWS-IF97/ASME (→ 48).
- Between warm water and cold water (second temperature read in via current input/HART/PROFIBUS PA/FOUNDATION Fieldbus) in accordance with IAPWS-IF97/ASME.

Vapor pressure and steam temperature

The measuring device can perform the following in saturated steam measurements between the feed line and return line of any heating liquid (second temperature read in via current input/HART/PROFIBUS PA/FOUNDATION Fieldbus and Cp value entered):

- Calculate the saturation pressure of the steam from the measured temperature and output the value in accordance with IAPWS-IF97/ASME.
- Calculate the saturation temperature of the steam from the specified pressure and output the value in accordance with IAPWS-IF97/ASME.

Saturated steam alarm

In applications involving the measurement of superheated steam, the measuring device can trigger a saturated steam alarm when the value approaches the saturation curve.

Total mass flow and condensate mass flow

- Using the steam quality entered, the measuring device can calculate the total mass flow and output it in the form of the proportion of gas and liquid.
- Using the steam quality entered, the measuring device can calculate the condensate mass flow and output it in the form of the proportion of liquid.

Measuring range

The measuring range depends on the fluid and nominal diameter.

Lower range value

Depends on the density and the Reynolds number ($Re_{min} = 5\,000$, $Re_{linear} = 20\,000$). The Reynolds number is dimensionless and indicates the ratio of the inertia force of a fluid to its viscous force. It is used to characterize the flow. The Reynolds number is calculated as follows:

$$Re = \frac{4 \cdot Q \text{ [m}^3\text{/s]} \cdot \rho \text{ [kg/m}^3\text{]}}{\pi \cdot di \text{ [m]} \cdot \mu \text{ [Pa}\cdot\text{s]}} \qquad Re = \frac{4 \cdot Q \text{ [ft}^3\text{/s]} \cdot \rho \text{ [lb/ft}^3\text{]}}{\pi \cdot di \text{ [ft]} \cdot \mu \text{ [0.001 cP]}}$$

A0003794

$Re =$ Reynolds number; $Q =$ flow; $di =$ internal diameter; $\mu =$ dynamic viscosity, $\rho =$ density

$$\begin{aligned} \text{DN 15...300} &\rightarrow v_{min.} = \frac{6}{\sqrt{\rho \text{ [kg/m}^3\text{]}}} \text{ [m/s]} \\ \text{DN } \frac{1}{2}\text{...12"} &\rightarrow v_{min.} = \frac{4.92}{\sqrt{\rho \text{ [lb/ft}^3\text{]}}} \text{ [ft/s]} \end{aligned}$$

A0003239

Upper range value

Liquids:

The upper range value must be calculated as follows:

$v_{max} = 9 \text{ m/s (30 ft/s)}$ and $v_{max} = 350/\sqrt{\rho} \text{ m/s (130/\sqrt{\rho} ft/s)}$

► Use the lower value.

Gas/steam:

Nominal diameter	v_{max}
Standard device: DN 15 (½")	46 m/s (151 ft/s) and $350/\sqrt{\rho} \text{ m/s (130/\sqrt{\rho} ft/s)}$ (Use the lower value.)
Standard device: DN 25 (1"), DN 40 (1½")	75 m/s (246 ft/s) and $350/\sqrt{\rho} \text{ m/s (130/\sqrt{\rho} ft/s)}$ (Use the lower value.)
Standard device: DN 50 to 300 (2 to 12")	120 m/s (394 ft/s) and $350/\sqrt{\rho} \text{ m/s (130/\sqrt{\rho} ft/s)}$ (Use the lower value.) Calibrated range: up to 75 m/s (246 ft/s)

 For information about the Applicator (→  94)

Operable flow range



Up to 45: 1 (ratio between lower and upper range value)

Input signal

External measured values

To increase the accuracy of certain measured variables or to calculate the corrected volume flow, the automation system can continuously write different measured values to the measuring device:

- Operating pressure to increase accuracy (Endress+Hauser recommends the use of a pressure measuring device for absolute pressure, e.g. Cerabar M or Cerabar S)
- Medium temperature to increase accuracy (e.g. iTEMP)
- Reference density for calculating the corrected volume flow

-  ■ Various pressure transmitters can be ordered from Endress+Hauser: see "Accessories" section (→  95)
- Please comply with the special mounting instructions when using pressure transmitters (→  48)

It is recommended to read in external measured values to calculate the following measured variables:

- Energy flow
- Mass flow
- Corrected volume flow

HART protocol

The measured values are written from the automation system to the measuring device via the HART protocol. The pressure transmitter must support the following protocol-specific functions:

- HART protocol
- Burst mode

Current input

The measured values are written from the automation system to the measuring device via the current input.

Fieldbuses

The measured values can be written from the automation system to the measuring via:

- PROFIBUS PA
- FOUNDATION Fieldbus

Current input

Current input	4 to 20 mA (passive)
Resolution	1 μ A
Voltage drop	Typically: 2.2 to 3 V for 3.6 to 22 mA
Maximum voltage	≤ 35 V
Possible input variables	<ul style="list-style-type: none"> ■ Pressure ■ Temperature ■ Density

Output



Output signal

Current output

Current output 1	4-20 mA HART (passive)
Current output 2	4-20 mA (passive)
Resolution	<1 μ A
Damping	Adjustable: 0.0 to 999.9 s
Assignable measured variables	<ul style="list-style-type: none"> ■ Volume flow ■ Corrected volume flow ■ Mass flow ■ Flow velocity ■ Temperature ■ Calculated saturated steam pressure ■ Total mass flow ■ Energy flow ■ Heat flow difference

Pulse/frequency/switch output

Function	Can be set to pulse, frequency or switch output
Version	Passive, open collector

Maximum input values	<ul style="list-style-type: none"> ▪ DC 35 V ▪ 50 mA <p> For information on the Ex connection values (→  17)</p>
Voltage drop	<ul style="list-style-type: none"> ▪ For ≤2 mA: 2 V ▪ For 10 mA: 8 V
Residual current	≤0.05 mA
Pulse output	
Pulse width	Adjustable: 5 to 2 000 ms
Maximum pulse rate	100 Impulse/s
Pulse value	Adjustable
Assignable measured variables	<ul style="list-style-type: none"> ▪ Total volume flow ▪ Total corrected volume flow ▪ Total mass flow ▪ Total energy flow ▪ Total heat flow difference
Frequency output	
Output frequency	Adjustable: 0 to 1 000 Hz
Damping	Adjustable: 0 to 999 s
Pulse/pause ratio	1:1
Assignable measured variables	<ul style="list-style-type: none"> ▪ Volume flow ▪ Corrected volume flow ▪ Mass flow ▪ Flow velocity ▪ Temperature ▪ Calculated saturated steam pressure ▪ Steam quality ▪ Total mass flow ▪ Energy flow ▪ Heat flow difference
Switch output	
Switching behavior	Binary, conductive or non-conductive
Switching delay	Adjustable: 0 to 100 s
Number of switching cycles	Unlimited
Assignable functions	<ul style="list-style-type: none"> ▪ Off ▪ On ▪ Diagnostic behavior ▪ Limit value <ul style="list-style-type: none"> - Volume flow - Corrected volume flow - Mass flow - Flow velocity - Temperature - Calculated saturated steam pressure - Steam quality - Total mass flow - Energy flow - Heat flow difference - Reynolds number - Totalizer 1-3 ▪ Status ▪ Status of low flow cut off

FOUNDATION Fieldbus

Signal encoding	Manchester Bus Powered (MBP)
Data transfer	31.25 KBit/s, Voltage mode

PROFIBUS PA

Signal encoding	Manchester Bus Powered (MBP)
Data transfer	31.25 KBit/s, Voltage mode

Signal on alarm

Depending on the interface, failure information is displayed as follows:

Current output*HART*

Device diagnostics	Device condition can be read out via HART Command 48
---------------------------	--

Pulse/frequency/switch output

Pulse output	
Failure mode	No pulses
Frequency output	
Failure mode	Choose from: <ul style="list-style-type: none"> ■ Actual value ■ Defined value: 0 to 1250 Hz ■ 0 Hz
Switch output	
Failure mode	Choose from: <ul style="list-style-type: none"> ■ Current status ■ Open ■ Closed

FOUNDATION Fieldbus

Status and alarm messages	Diagnostics in accordance with FF-912
Error current FDE (Fault Disconnection Electronic)	0 mA

PROFIBUS PA

Status and alarm messages	Diagnostics in accordance with PROFIBUS PA Profile 3.02
Error current FDE (Fault Disconnection Electronic)	0 mA

Local display



Plain text display	With information on cause and remedial measures
Backlight	Additionally for device version with SD03 local display: red lighting indicates a device error.

 Status signal as per NAMUR recommendation NE 107

Operating tool

- Via digital communication:
 - HART protocol
 - FOUNDATION Fieldbus
 - PROFIBUS PA
- Via service interface

Plain text display	With information on cause and remedial measures
---------------------------	---

 Additional information on remote operation (→  85)

Load

Load for current output: 0 to 500 Ω, depending on the external supply voltage of the power supply unit

Calculation of the maximum load

Depending on the supply voltage of the power supply unit (U_S), the maximum load (R_B) including line resistance must be observed to ensure adequate terminal voltage at the device. In doing so, observe the minimum terminal voltage (→  31)

- $R_B \leq (U_S - U_{\text{term. min}}) : 0.022 \text{ A}$
- $R_B \leq 500 \text{ } \Omega$

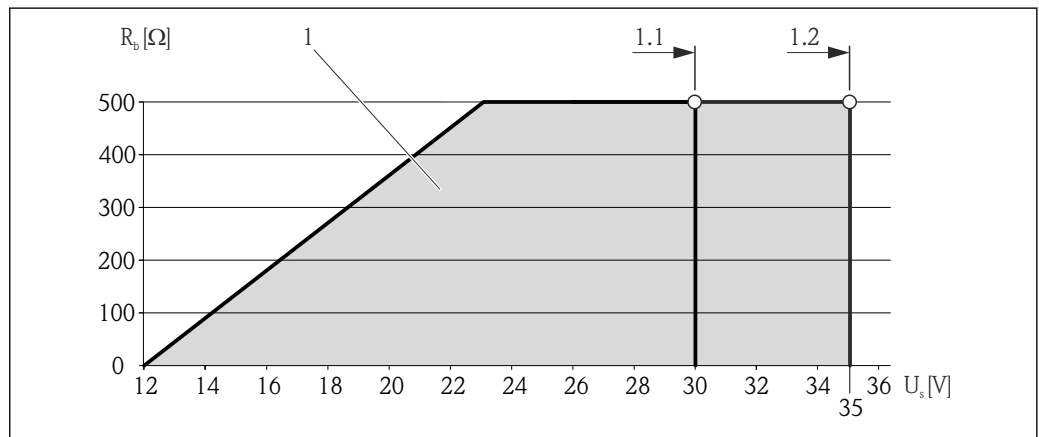

 2 Load for a compact version without local operation

1 Operating range

1.1 For order code for "Output", option A "4-20 mA HART"/option B "4-20 mA HART, pulse/frequency/switch output" with Ex i and option C "4-20 mA HART, 4-20 mA"



1.2 For order code for "Output", option A "4-20 mA HART"/option B "4-20 mA HART, pulse/frequency/switch output" with non-Ex and Ex d

Sample calculation

Supply voltage of the supply unit:

- $U_S = 19 \text{ V}$
- $U_{\text{term. min}} = 12 \text{ V (measuring device)} + 1 \text{ V (local operation without lighting)} = 13 \text{ V}$

Maximum load: $R_B \leq (19 \text{ V} - 13 \text{ V}) : 0.022 \text{ A} = 273 \text{ } \Omega$

 The minimum terminal voltage ($U_{\text{term. min}}$) increases if local operation is used (→  31).

Ex connection data

Safety-related values

Ex d type of protection

Order code for "Output"	Output type	Safety-related values
Option A	4-20mA HART	$U_{nom} = DC 35 V$ $U_{max} = 250 V$
Option B	4-20mA HART	$U_{nom} = DC 35 V$ $U_{max} = 250 V$
	Pulse/frequency/switch output	$U_{nom} = DC 35 V$ $U_{max} = 250 V$ $P_{max} = 1 W^{1)}$
Option C	4-20mA HART	$U_{nom} = DC 30 V$ $U_{max} = 250 V$
	4-20mA	$U_{max} = 250 V$
Option D	4-20mA HART	$U_{nom} = DC 35 V$ $U_{max} = 250 V$
	Pulse/frequency/switch output	$U_{nom} = DC 35 V$ $U_{max} = 250 V$ $P_{max} = 1 W^{1)}$
	4 to 20 mA current input	$U_{nom} = DC 35 V$ $U_{max} = 250 V$
Option E	FOUNDATION Fieldbus	$U_{nom} = DC 32 V$ $U_{max} = 250 V$ $P_{max} = 0.88 W$
	Pulse/frequency/switch output	$U_{nom} = DC 35 V$ $U_{max} = 250 V$ $P_{max} = 1 W^{1)}$
Option G	PROFIBUS PA	$U_{nom} = DC 32 V$ $U_{max} = 250 V$ $P_{max} = 0.88 W$
	Pulse/frequency/switch output	$U_{nom} = DC 35 V$ $U_{max} = 250 V$ $P_{max} = 1 W^{1)}$

1) Internal circuit limited by $R_i = 760.5 \Omega$

Ex nA type of protection

Order code for "Output"	Output type	Safety-related values
Option A	4-20mA HART	$U_{nom} = DC 35 V$ $U_{max} = 250 V$
Option B	4-20mA HART	$U_{nom} = DC 35 V$ $U_{max} = 250 V$
	Pulse/frequency/switch output	$U_{nom} = DC 35 V$ $U_{max} = 250 V$ $P_{max} = 1 W^{1)}$
Option C	4-20mA HART	$U_{nom} = DC 30 V$ $U_{max} = 250 V$
	4-20mA	$U_{max} = 250 V$
Option D	4-20mA HART	$U_{nom} = DC 35 V$ $U_{max} = 250 V$
	Pulse/frequency/switch output	$U_{nom} = DC 35 V$ $U_{max} = 250 V$ $P_{max} = 1 W$
	4 to 20 mA current input	$U_{nom} = DC 35 V$ $U_{max} = 250 V$

Order code for "Output"	Output type	Safety-related values
Option E	FOUNDATION Fieldbus	$U_{nom} = DC 32 V$ $U_{max} = 250 V$ $P_{max} = 0.88 W$
	Pulse/frequency/switch output	$U_{nom} = DC 35 V$ $U_{max} = 250 V$ $P_{max} = 1 W$
Option G	PROFIBUS PA	$U_{nom} = DC 32 V$ $U_{max} = 250 V$ $P_{max} = 0.88 W$
	Pulse/frequency/switch output	$U_{nom} = DC 35 V$ $U_{max} = 250 V$ $P_{max} = 1 W$

1) Internal circuit limited by $R_i = 760.5 \Omega$

Type of protection XP

Order code for "Output"	Output type	Safety-related values
Option A	4-20mA HART	$U_{nom} = DC 35 V$ $U_{max} = 250 V$
Option B	4-20mA HART	$U_{nom} = DC 35 V$ $U_{max} = 250 V$
	Pulse/frequency/switch output	$U_{nom} = DC 35 V$ $U_{max} = 250 V$ $P_{max} = 1 W$ ¹⁾
Option C	4-20mA HART	$U_{nom} = DC 30 V$ $U_{max} = 250 V$
	4-20mA	
Option D	4-20mA HART	$U_{nom} = DC 35 V$ $U_{max} = 250 V$
	Pulse/frequency/switch output	$U_{nom} = DC 35 V$ $U_{max} = 250 V$ $P_{max} = 1 W$
	4 to 20 mA current input	$U_{nom} = DC 35 V$ $U_{max} = 250 V$
Option E	FOUNDATION Fieldbus	$U_{nom} = DC 32 V$ $U_{max} = 250 V$ $P_{max} = 0.88 W$
	Pulse/frequency/switch output	$U_{nom} = DC 35 V$ $U_{max} = 250 V$ $P_{max} = 1 W$
Option G	PROFIBUS PA	$U_{nom} = DC 32 V$ $U_{max} = 250 V$ $P_{max} = 0.88 W$
	Pulse/frequency/switch output	$U_{nom} = DC 35 V$ $U_{max} = 250 V$ $P_{max} = 1 W$

1) Internal circuit limited by $R_i = 760.5 \Omega$

Intrinsically safe values

Type of protection Ex ia

Order code for "Output"	Output type	Intrinsically safe values	
Option A	4-20mA HART	$U_i = DC 30 V$ $I_i = 300 mA$ $P_i = 1 W$ $L_i = 0 \mu H$ $C_i = 5 nF$	
Option B	4-20mA HART	$U_i = DC 30 V$ $I_i = 300 mA$ $P_i = 1 W$ $L_i = 0 \mu H$ $C_i = 5 nF$	
	Pulse/frequency/switch output	$U_i = DC 30 V$ $I_i = 300 mA$ $P_i = 1 W$ $L_i = 0 \mu H$ $C_i = 6 nF$	
Option C	4-20mA HART	$U_i = DC 30 V$ $I_i = 300 mA$ $P_i = 1 W$ $L_i = 0 \mu H$ $C_i = 30 nF$	
	4-20mA		
Option D	4-20mA HART	$U_i = DC 30 V$ $I_i = 300 mA$ $P_i = 1 W$ $L_i = 0 \mu H$ $C_i = 5 nF$	
	Pulse/frequency/switch output	$U_i = DC 30 V$ $I_i = 300 mA$ $P_i = 1 W$ $L_i = 0 \mu H$ $C_i = 6 nF$	
	4 to 20 mA current input	$U_i = DC 30 V$ $I_i = 300 mA$ $P_i = 1 W$ $L_i = 0 \mu H$ $C_i = 5 nF$	
Option E	FOUNDATION Fieldbus	STANDARD $U_i = 30 V$ $I_i = 300 mA$ $P_i = 1.2 W$ $L_i = 10 \mu H$ $C_i = 5 nF$	FISCO $U_i = 17.5 V$ $I_i = 550 mA$ $P_i = 5.5 W$ $L_i = 10 \mu H$ $C_i = 5 nF$
	Pulse/frequency/switch output	$U_i = 30 V$ $I_i = 300 mA$ $P_i = 1 W$ $L_i = 0 \mu H$ $C_i = 6 nF$	
Option G	PROFIBUS PA	STANDARD $U_i = 30 V$ $I_i = 300 mA$ $P_i = 1.2 W$ $L_i = 10 \mu H$ $C_i = 5 nF$	FISCO $U_i = 17.5 V$ $I_i = 550 mA$ $P_i = 5.5 W$ $L_i = 10 \mu H$ $C_i = 5 nF$

Type of protection Ex ic

Order code for "Output"	Output type	Intrinsically safe values	
Option A	4-20mA HART	$U_i = DC\ 35\ V$ $I_i = n.a.$ $P_i = 1\ W$ $L_i = 0\ \mu H$ $C_i = 5\ nF$	
Option B	4-20mA HART	$U_i = DC\ 35\ V$ $I_i = n.a.$ $P_i = 1\ W$ $L_i = 0\ \mu H$ $C_i = 5\ nF$	
	Pulse/frequency/switch output	$U_i = DC\ 35\ V$ $I_i = n.a.$ $P_i = 1\ W$ $L_i = 0\ \mu H$ $C_i = 6\ nF$	
Option C	4-20mA HART	$U_i = DC\ 30\ V$ $I_i = n.a.$ $P_i = 1\ W$ $L_i = 0\ \mu H$ $C_i = 30\ nF$	
	4-20mA		
Option D	4-20mA HART	$U_i = DC\ 35\ V$ $I_i = n.a.$ $P_i = 1\ W$ $L_i = 0\ \mu H$ $C_i = 5\ nF$	
	Pulse/frequency/switch output	$U_i = DC\ 35\ V$ $I_i = n.a.$ $P_i = 1\ W$ $L_i = 0\ \mu H$ $C_i = 6\ nF$	
	4 to 20 mA current input	$U_i = DC\ 35\ V$ $I_i = n.a.$ $P_i = 1\ W$ $L_i = 0\ \mu H$ $C_i = 5\ nF$	
Option E	FOUNDATION Fieldbus	STANDARD $U_i = 32\ V$ $I_i = 300\ mA$ $P_i = n.a.$ $L_i = 10\ \mu H$ $C_i = 5\ nF$	FISCO $U_i = 17.5\ V$ $I_i = n.a.$ $P_i = n.a.$ $L_i = 10\ \mu H$ $C_i = 5\ nF$
	Pulse/frequency/switch output	$U_i = 35\ V$ $I_i = 300\ mA$ $P_i = 1\ W$ $L_i = 0\ \mu H$ $C_i = 6\ nF$	
Option G	PROFIBUS PA	STANDARD $U_i = 32\ V$ $I_i = 300\ mA$ $P_i = n.a.$ $L_i = 10\ \mu H$ $C_i = 5\ nF$	FISCO $U_i = 17.5\ V$ $I_i = n.a.$ $P_i = n.a.$ $L_i = 10\ \mu H$ $C_i = 5\ nF$
	Pulse/frequency/switch output	$U_i = 35\ V$ $I_i = 300\ mA$ $P_i = 1\ W$ $L_i = 0\ \mu H$ $C_i = 6\ nF$	

IS type of protection

Order code for "Output"	Output type	Intrinsically safe values	
Option A	4-20mA HART	$U_i = DC\ 30\ V$ $I_i = 300\ mA$ $P_i = 1\ W$ $L_i = 0\ \mu H$ $C_i = 5\ nF$	
Option B	4-20mA HART	$U_i = DC\ 30\ V$ $I_i = 300\ mA$ $P_i = 1\ W$ $L_i = 0\ \mu H$ $C_i = 5\ nF$	
	Pulse/frequency/switch output	$U_i = DC\ 30\ V$ $I_i = 300\ mA$ $P_i = 1\ W$ $L_i = 0\ \mu H$ $C_i = 6\ nF$	
Option C	4-20mA HART	$U_i = DC\ 30\ V$ $I_i = 300\ mA$ $P_i = 1\ W$ $L_i = 0\ \mu H$ $C_i = 30\ nF$	
	4-20mA		
Option D	4-20mA HART	$U_i = DC\ 30\ V$ $I_i = 300\ mA$ $P_i = 1\ W$ $L_i = 0\ \mu H$ $C_i = 5\ nF$	
	Pulse/frequency/switch output	$U_i = DC\ 30\ V$ $I_i = 300\ mA$ $P_i = 1\ W$ $L_i = 0\ \mu H$ $C_i = 6\ nF$	
	4 to 20 mA current input	$U_i = DC\ 30\ V$ $I_i = 300\ mA$ $P_i = 1\ W$ $L_i = 0\ \mu H$ $C_i = 5\ nF$	
Option E	FOUNDATION Fieldbus	STANDARD $U_i = 30\ V$ $I_i = 300\ mA$ $P_i = 1.2\ W$ $L_i = 10\ \mu H$ $C_i = 5\ nF$	FISCO $U_i = 17.5\ V$ $I_i = 550\ mA$ $P_i = 5.5\ W$ $L_i = 10\ \mu H$ $C_i = 5\ nF$
	Pulse/frequency/switch output	$U_i = 30\ V$ $I_i = 300\ mA$ $P_i = 1\ W$ $L_i = 0\ \mu H$ $C_i = 6\ nF$	
Option G	PROFIBUS PA	STANDARD $U_i = 30\ V$ $I_i = 300\ mA$ $P_i = 1.2\ W$ $L_i = 10\ \mu H$ $C_i = 5\ nF$	FISCO $U_i = 17.5\ V$ $I_i = 550\ mA$ $P_i = 5.5\ W$ $L_i = 10\ \mu H$ $C_i = 5\ nF$
	Pulse/frequency/switch output	$U_i = 30\ V$ $I_i = 300\ mA$ $P_i = 1\ W$ $L_i = 0\ \mu H$ $C_i = 6\ nF$	

Low flow cut off

The switch points for low flow cut off are user-selectable.

Galvanic isolation All outputs are galvanically isolated from one another.

Protocol-specific data **HART**

Manufacturer ID	0x11
Device type ID	0x38
HART protocol revision	7.4
Device description files (DTM, DD)	Information and files under: www.endress.com
HART load	<ul style="list-style-type: none">▪ Min. 250 Ω▪ Max. 500 Ω

Dynamic variables	<p>Read out the dynamic variables: HART command 3 The measured variables can be freely assigned to the dynamic variables.</p> <p>Measured variables for PV (primary dynamic variable)</p> <ul style="list-style-type: none"> ▪ Volume flow ▪ Corrected volume flow ▪ Mass flow ▪ Flow velocity ▪ Temperature ▪ Calculated saturated steam pressure ▪ Steam quality ▪ Total mass flow ▪ Energy flow ▪ Heat flow difference <p>Measured variables for SV, TV, QV (secondary, tertiary and quaternary dynamic variable)</p> <ul style="list-style-type: none"> ▪ Volume flow ▪ Corrected volume flow ▪ Mass flow ▪ Flow velocity ▪ Temperature ▪ Calculated saturated steam pressure ▪ Steam quality ▪ Total mass flow ▪ Energy flow ▪ Heat flow difference ▪ Condensate mass flow ▪ Reynolds number ▪ Totalizer 1 ▪ Totalizer 2 ▪ Totalizer 3 ▪ HART input ▪ Density ▪ Pressure ▪ Specific volume ▪ Degree of overheating
Device variables	<p>Read out the device variables: HART command 9 The device variables are permanently assigned.</p> <p>A maximum of 8 device variables can be transmitted:</p> <ul style="list-style-type: none"> ▪ 0 = volume flow ▪ 1 = corrected volume flow ▪ 2 = Mass flow ▪ 3 = flow velocity ▪ 4 = temperature ▪ 5 = calculated saturated steam pressure ▪ 6 = steam quality ▪ 7 = total mass flow ▪ 8 = energy flow ▪ 9 = heat flow difference ▪ 10 = condensate mass flow ▪ 11 = Reynolds number ▪ 12 = totalizer 1 ▪ 13 = totalizer 2 ▪ 14 = totalizer 3 ▪ 15 = HART input ▪ 16 = density ▪ 17 = pressure ▪ 18 = specific volume ▪ 19 = degree of overheating

FOUNDATION Fieldbus

Manufacturer ID	0x452B48
Ident number	0x1038
Device revision	1

DD revision	Information and files under: <ul style="list-style-type: none"> ▪ www.endress.com ▪ www.fieldbus.org
CFF revision	
Device Tester Version (ITK version)	6.1.1
ITK Test Campaign Number	IT094200
Link Master capability (LAS)	Yes
Choice of "Link Master" and "Basic Device"	Yes Factory setting: Basic Device
Node address	Factory setting: 247 (0xF7)
Supported functions	The following methods are supported: <ul style="list-style-type: none"> ▪ Restart ▪ ENP Restart ▪ Diagnostic
Virtual Communication Relationships (VCRs)	
Number of VCRs	44
Number of link objects in VFD	50
Permanent entries	1
Client VCRs	0
Server VCRs	10
Source VCRs	43
Sink VCRs	0
Subscriber VCRs	43
Publisher VCRs	43
Device Link Capabilities	
Slot time	4
Min. delay between PDU	8
Max. response delay	Min. 5

Transducer Blocks

Block	Contents	Output values
Setup Transducer Block (TRDSUP)	All parameters for standard commissioning.	No output values
Advanced Setup Transducer Block (TRDASUP)	All parameters for more accurate measurement configuration.	No output values
Display Transducer Block (TRDDISP)	Parameters for configuring the local display.	No output values
HistoROM Transducer Block (TRDHROM)	Parameters for using the HistoROM function.	No output values

Block	Contents	Output values
Diagnostic Transducer Block (TRDDIAG)	Diagnostics information.	Process variables (AI Channel) <ul style="list-style-type: none"> ■ Mass flow (11) ■ Flow velocity (37) ■ Condensate mass flow (47) ■ Total mass flow (46) ■ Volume flow (9) ■ Corrected volume flow (13) ■ Temperature (7) ■ Calculated saturated steam pressure (45) ■ Steam quality (48) ■ Energy flow (38) ■ Heat flow difference (49) ■ Reynolds number (50)
Expert Configuration Transducer Block (TRDEXP)	Parameters that require the user to have in-depth knowledge of the operation of the device in order to configure the parameters appropriately.	No output values
Expert Information Transducer Block (TRDEXPIN)	Parameters that provide information about the state of the device.	No output values
Service Sensor Transducer Block (TRDSRVS)	Parameters that can only be accessed by Endress+Hauser Service.	No output values
Service Information Transducer Block (TRDSRVIF)	Parameters that provide Endress+Hauser Service with information about the state of the device.	No output values
Total Inventory Counter Transducer Block (TRDTIC)	Parameters for configuring all the totalizers and the inventory counter.	Process variables (AI Channel) <ul style="list-style-type: none"> ■ Totalizer 1 (16) ■ Totalizer 2 (17) ■ Totalizer 3 (18)
Heartbeat Technology Transducer Block (TRDHBT)	Parameters for the configuration and comprehensive information about the results of the verification.	No output values
Heartbeat Results 1 Transducer Block (TRDHBTR1)	Information about the results of the verification.	No output values
Heartbeat Results 2 Transducer Block (TRDHBTR2)	Information about the results of the verification.	No output values
Heartbeat Results 3 Transducer Block (TRDHBTR3)	Information about the results of the verification.	No output values
Heartbeat Results 4 Transducer Block (TRDHBTR4)	Information about the results of the verification.	No output values

Function blocks

Block	Number of Blocks	Contents	Process variables (Channel)
Resource Block (RB)	1	This Block (extended functionality) contains all the data that uniquely identify the device; it is the equivalent of an electronic nameplate for the device.	–
Analog Input Block (AI)	4	This Block (extended functionality) receives the measurement data provided by the Sensor Block (can be selected via a channel number) and makes the data available for other blocks at the output. Execution time: 13 ms	<ul style="list-style-type: none"> ▪ Temperature (7) ▪ Mass flow (11) ▪ Volume flow (9) ▪ Corrected volume flow (13) ▪ Flow velocity (37) ▪ Energy flow (38) ▪ Calculated saturated steam pressure (45) ▪ Total mass flow (46) ▪ Condensate mass flow (47) ▪ Steam quality (48) ▪ Heat flow difference (49) ▪ Reynolds number (50)
Discrete Input Block (DI)	1	This Block (standard functionality) receives a discrete value (e.g. indicator that measuring range has been exceeded) and makes the value available for other blocks at the output. Execution time: 12 ms	<ul style="list-style-type: none"> ▪ Status switch output (101) ▪ Low flow cutoff (103) ▪ Status verification (105)
PID Block (PID)	1	This Block (standard functionality) acts as a proportional-integral-differential controller and can be used universally for control in the field. It enables cascading and feedforward control. Execution time: 13 ms	–
Multiple Analog Output Block (MAO)	1	This Block (standard functionality) receives several analog values and makes them available for other blocks at the output. Execution time: 11 ms	<p>Channel_0 (121)</p> <ul style="list-style-type: none"> ▪ Value 1: External compensation variables (pressure, gage pressure, density, temperature or second temperature) ▪ Value 2 to 8: Not assigned <p> The compensation variables must be transmitted to the device in the SI basic unit.</p>

Block	Number of Blocks	Contents	Process variables (Channel)
Multiple Digital Output Block (MDO)	1	This Block (standard functionality) receives several discrete values and makes them available for other blocks at the output. Execution time: 14 ms	Channel_DO (122) <ul style="list-style-type: none"> ■ Value 1: Reset totalizer 1 ■ Value 2: Reset totalizer 2 ■ Value 3: Reset totalizer 3 ■ Value 4: Flow override ■ Value 5: Start heartbeat verification ■ Value 6: Status switch output ■ Value 7: Not assigned ■ Value 8: Not assigned
Integrator Block (IT)	1	This Block (standard functionality) integrates a measured variable over time or totalizes the pulses from a Pulse Input Block. The Block can be used as a totalizer that totalizes until a reset, or as a batch totalizer whereby the integrated value is compared against a target value generated before or during the control routine and generates a binary signal when the target value is reached. Execution time: 16 ms	–

PROFIBUS PA

Manufacturer ID	0x11
Ident number	0x1564
Profile version	3.02
Device description files (GSD, DTM, DD)	Information and files under: <ul style="list-style-type: none"> ■ www.endress.com ■ www.profibus.org
Output values (from measuring device to automation system)	<p>Analog input 1 to 4</p> <ul style="list-style-type: none"> ■ Mass flow ■ Volume flow ■ Corrected volume flow ■ Density ■ Reference density ■ Temperature ■ Pressure ■ Specific volume ■ Degree of overheating <p>Digital input 1 to 2</p> <ul style="list-style-type: none"> ■ Status ■ Low flow cut off ■ Switch output <p>Totalizer 1 to 3</p> <ul style="list-style-type: none"> ■ Mass flow ■ Volume flow ■ Corrected volume flow
Input values (from automation system to measuring device)	<p>Analog output External pressure, gage pressure, density, temperature or second temperature (for delta heat measurement)</p> <p>Digital output 1 to 3 (fixed assignment)</p> <ul style="list-style-type: none"> ■ Digital output 1: switch flow override on/off ■ Digital output 2: switch switch output on/off ■ Digital output 3: Start verification <p>Totalizer 1 to 3</p> <ul style="list-style-type: none"> ■ Totalize ■ Reset and hold ■ Preset and hold

Supported functions	<ul style="list-style-type: none"> ▪ Identification & Maintenance Simplest device identification on the part of the control system and nameplate ▪ PROFIBUS upload/download Reading and writing parameters is up to ten times faster with PROFIBUS upload/download ▪ Condensed status Simplest and self-explanatory diagnostic information by categorizing diagnostic messages that occur
Configuration of the device address	<ul style="list-style-type: none"> ▪ DIP switches on the I/O electronics module ▪ Local display ▪ Via operating tools (e.g. FieldCare)

Power supply

Terminal assignment

Transmitter

Connection versions

<small>A0020738</small>	<small>A0020739</small>
<p><i>Maximum number of terminals</i> Terminals 1 to 6: Without integrated overvoltage protection</p>	<p><i>Maximum number of terminals for order code for "Accessory mounted", option NA "Overvoltage protection"</i></p> <ul style="list-style-type: none"> ▪ Terminals 1 to 4: With integrated overvoltage protection ▪ Terminals 5 to 6: Without integrated overvoltage protection
<p>1 Output 1 (passive): supply voltage and signal transmission 2 Output 2 (passive): supply voltage and signal transmission 3 Input (passive): supply voltage and signal transmission 4 Ground terminal for cable shield</p>	

Order code for "Output"	Terminal numbers					
	Output 1		Output 2		Input	
	1 (+)	2 (-)	3 (+)	4 (-)	5 (+)	6 (-)
Option A	4-20 mA HART (passive)		-		-	
Option B ¹⁾	4-20 mA HART (passive)		Pulse/frequency/switch output (passive)		-	
Option C ¹⁾	4-20 mA HART (passive)		4-20 mA (passive)		-	
Option D ^{1) 2)}	4-20 mA HART (passive)		Pulse/frequency/switch output (passive)		4-20 mA current input (passive)	

Order code for "Output"	Terminal numbers					
	Output 1		Output 2		Input	
	1 (+)	2 (-)	3 (+)	4 (-)	5 (+)	6 (-)
Option E ^{1) 3)}	FOUNDATION Fieldbus		Pulse/frequency/switch output (passive)		-	
Option G ^{1) 4)}	PROFIBUS PA		Pulse/frequency/switch output (passive)		-	

- 1) Output 1 must always be used; output 2 is optional.
- 2) The integrated overvoltage protection is not used with option D: Terminals 5 and 6 (current input) are not protected against overvoltage.
- 3) FOUNDATION Fieldbus with integrated reverse polarity protection.
- 4) PROFIBUS PA with integrated reverse polarity protection.

Remote version

In the case of the remote version, the sensor and transmitter are mounted separately from one another and connected by a connecting cable. The sensor is connected via the connection housing while the transmitter is connected via the connection compartment of the wall holder unit.

i The way the transmitter wall holder is connected depends on the measuring device approval and the version of the connecting cable used.

Connection is only possible via terminals:

- For approvals Ex n, Ex tb and cCSAus Div. 1
- If a reinforced connecting cable is used

The connection is via an M12 connector:

- For all other approvals
- If the standard connecting cable is used

Connection to the connection housing of the sensor is always via terminals.

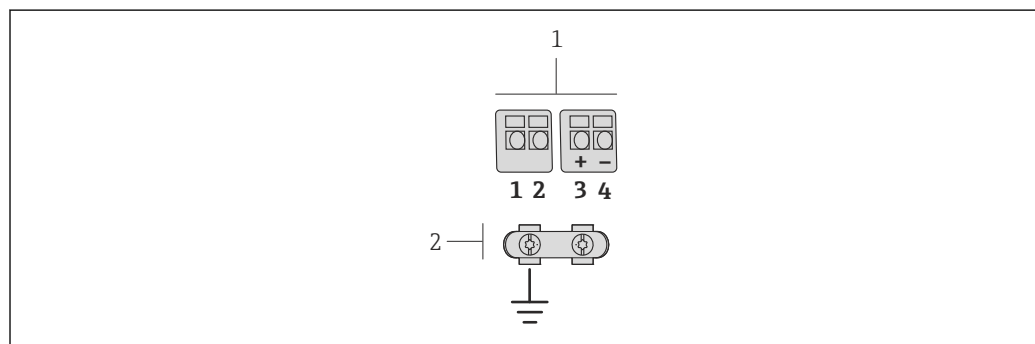

3 Terminals for connection compartment in the transmitter wall holder and the sensor connection housing

1 Terminals for connecting cable

2 Grounding via the cable strain relief

Terminal number	Assignment	Cable color Connecting cable
1	Supply voltage	Brown
2	Grounding	White
3	RS485 (+)	Yellow
4	RS485 (-)	Green

Pin assignment, device plug PROFIBUS PA

Device plug for signal transmission (device side)

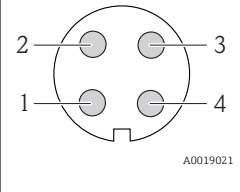
	Pin	Assignment	Coding	Plug/socket	
	1	+			PROFIBUS PA +
	2				Grounding
	3	-			PROFIBUS PA -
4		Not assigned			

FOUNDATION Fieldbus

Device plug for signal transmission (device side)

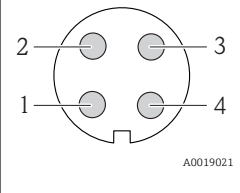
	Pin	Assignment	Coding	Plug/socket	
	1	+			Signal +
	2	-			Signal -
	3				Not assigned
4		Grounding			

Supply voltage

Transmitter

An external power supply is required for each output.

Supply voltage for a compact version without a local display ¹⁾

Order code for "Output"	Minimum terminal voltage ²⁾	Maximum terminal voltage
Option A : 4-20 mA HART	≥DC 12 V	DC 35 V
Option B : 4-20 mA HART, pulse/frequency/switch output	≥DC 12 V	DC 35 V
Option C : 4-20 mA HART, 4-20 mA	≥DC 12 V	DC 30 V
Option D : 4-20 mA HART, pulse/frequency/switch output, 4-20 mA current input ³⁾	≥DC 12 V	DC 35 V
Option E : FOUNDATION Fieldbus, pulse/frequency/switch output	≥DC 9 V	DC 32 V
Option G : PROFIBUS PA, pulse/frequency/switch output	≥DC 9 V	DC 32 V

- 1) In event of external supply voltage of the power supply unit with load
- 2) The minimum terminal voltage increases if local operation is used: see the following table
- 3) Voltage drop 2.2 to 3 V for 3.59 to 22 mA

Increase in minimum terminal voltage

Local operation	Increase in minimum terminal voltage
Order code for "Display; Operation", option C : Local operation SDO2	+ DC 1 V
Order code for "Display; Operation", option E : Local operation SDO3 with lighting (backlighting not used)	+ DC 1 V
Order code for "Display; Operation", option E : Local operation SDO3 with lighting (backlighting used)	+ DC 3 V

 For information about the load see (→  17)



 Various power supply units can be ordered from Endress+Hauser: see "Accessories" section (→  95)

 For information on the Ex connection values (→  17)

Power consumption

Transmitter

Order code for "Output"	Maximum power consumption
Option A: 4-20 mA HART	770 mW
Option B: 4-20 mA HART, pulse/frequency/switch output	<ul style="list-style-type: none"> ▪ Operation with output 1: 770 mW ▪ Operation with output 1 and 2: 2 770 mW
Option C: 4-20 mA HART, 4-20 mA	<ul style="list-style-type: none"> ▪ Operation with output 1: 660 mW ▪ Operation with output 1 and 2: 1 320 mW
Option D: 4-20 mA HART, pulse/frequency/switch output, 4-20 mA current input	<ul style="list-style-type: none"> ▪ Operation with output 1: 770 mW ▪ Operation with output 1 and 2: 2 770 mW ▪ Operation with output 1 and input: 840 mW ▪ Operation with output 1, 2 and input: 2 840 mW
Option E: FOUNDATION Fieldbus, pulse/frequency/switch output	<ul style="list-style-type: none"> ▪ Operation with output 1: 512 mW ▪ Operation with output 1 and 2: 2 512 mW
Option G: PROFIBUS PA, pulse/frequency/switch output	<ul style="list-style-type: none"> ▪ Operation with output 1: 512 mW ▪ Operation with output 1 and 2: 2 512 mW

 For information on the Ex connection values (→  17)

Current consumption

Current output

For every 4-20 mA or 4-20 mA HART current output: 3.6 to 22.5 mA

 If the option **Defined value** is selected in the **Failure mode** parameter (→  16): 3.59 to 22.5 mA

Current input

3.59 to 22.5 mA

 Internal current limiting: max. 26 mA

PROFIBUS PA

15 mA

FOUNDATION Fieldbus

15 mA

Power supply failure

- Totalizers stop at the last value measured.
- Configuration is retained in the device memory (HistoROM).
- Error messages (incl. total operated hours) are stored.

Electrical connection

Connecting the transmitter

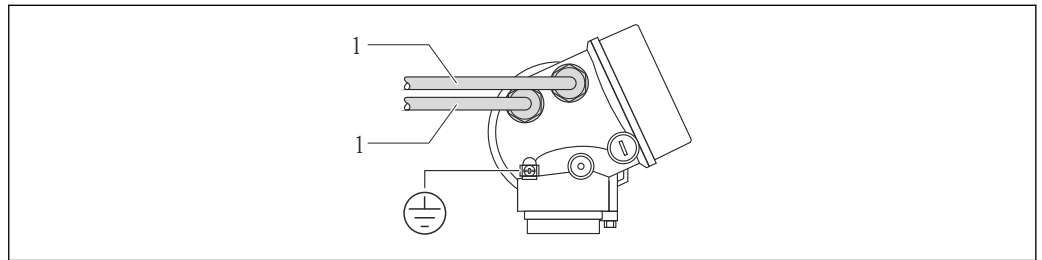

A0020740

1 Cable entries for inputs/outputs

Remote version connection

Connecting cable

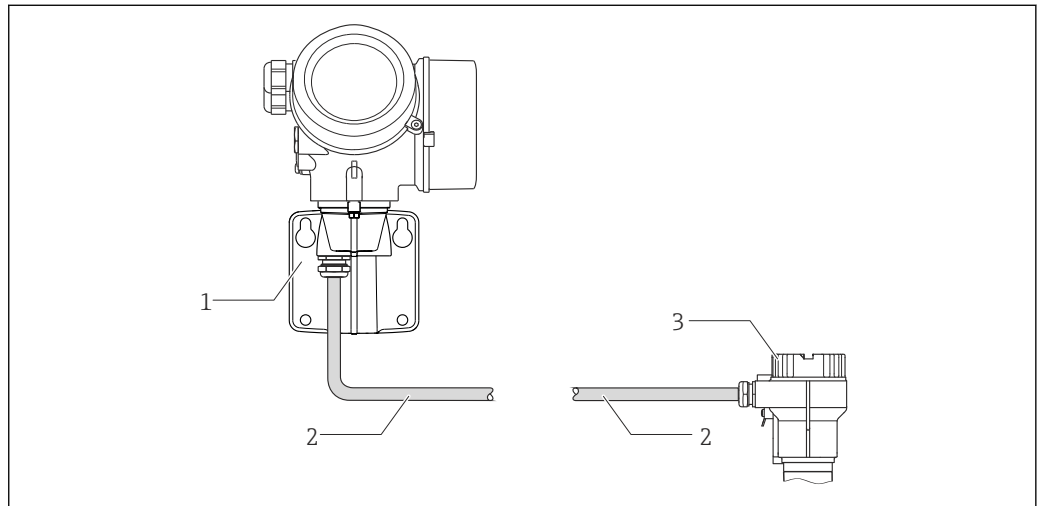

A0019727

4 Connecting cable connection

- 1 Wall holder with connection compartment (transmitter)
- 2 Connecting cable
- 3 Sensor connection housing

i The way the transmitter wall holder is connected depends on the measuring device approval and the version of the connecting cable used.

Connection is only possible via terminals:

- For approvals Ex n, Ex tb and cCSAus Div. 1
- If a reinforced connecting cable is used

The connection is via an M12 connector:

- For all other approvals
- If the standard connecting cable is used

Connection to the connection housing of the sensor is always via terminals.

Connection examples

Current output 4-20 mA HART

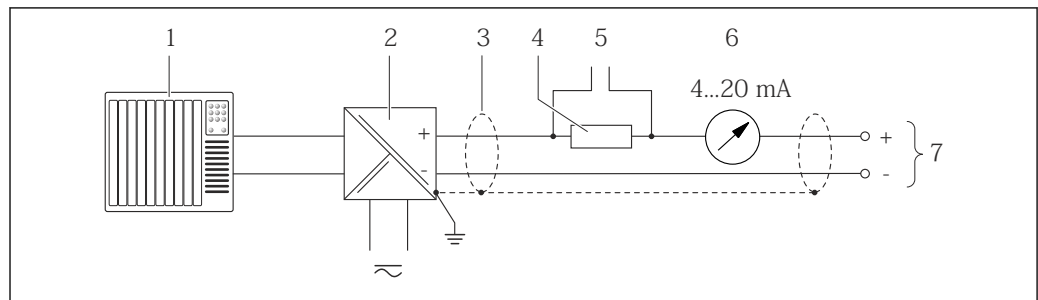

A0015511

5 Connection example for 4-20 mA HART current output (passive)

- 1 Automation system with current input (e.g. PLC)
- 2 Active barrier for power supply (e.g. RN221N) (→ 38)
- 3 Cable shield, observe cable specifications (→ 38)
- 4 Resistor for HART communication ($\geq 250 \Omega$): observe maximum load (→ 17)
- 5 Connection for HART operating devices (→ 85)
- 6 Analog display unit: observe maximum load (→ 17)
- 7 Transmitter

Current output 4-20 mA

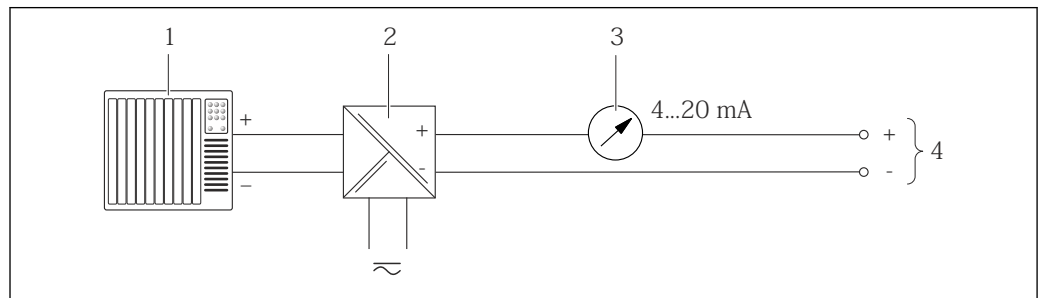

A0015512

6 Connection example for 4-20 mA current output (passive)

- 1 Automation system with current input (e.g. PLC)
- 2 Active barrier for power supply (e.g. RN221N) (→ 31)
- 3 Analog display unit: observe maximum load (→ 17)
- 4 Transmitter

Pulse/frequency output

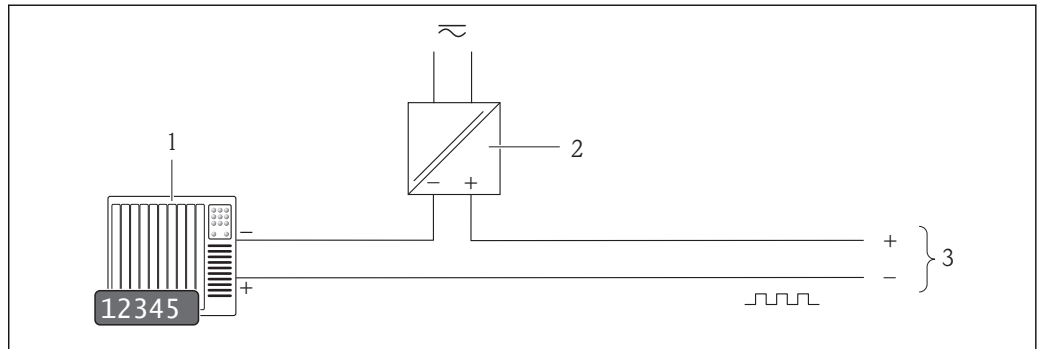

A0016801

7 Connection example for pulse/frequency output (passive)

- 1 Automation system with pulse/frequency input (e.g. PLC)
- 2 Power supply
- 3 Transmitter: observe input values (→ 14)

Switch output

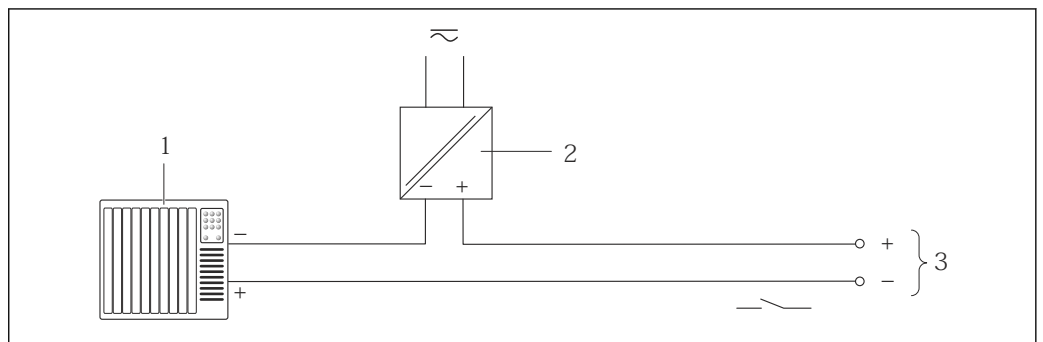

A0016802

8 Connection example for switch output (passive)

- 1 Automation system with switch input (e.g. PLC)
- 2 Power supply
- 3 Transmitter: observe input values (→ 14)

PROFIBUS-PA

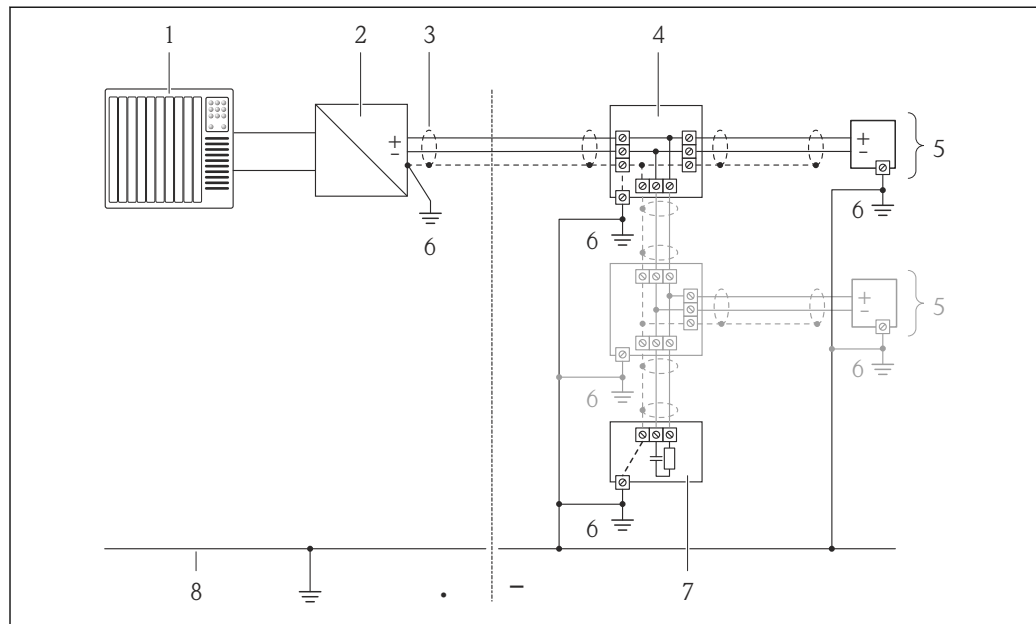

A0019004

9 Connection example for PROFIBUS-PA

- 1 Control system (e.g. PLC)
- 2 Segment coupler PROFIBUS DP/PA
- 3 Cable shield
- 4 T-box
- 5 Measuring device
- 6 Local grounding
- 7 Bus terminator
- 8 Potential matching line

FOUNDATION Fieldbus

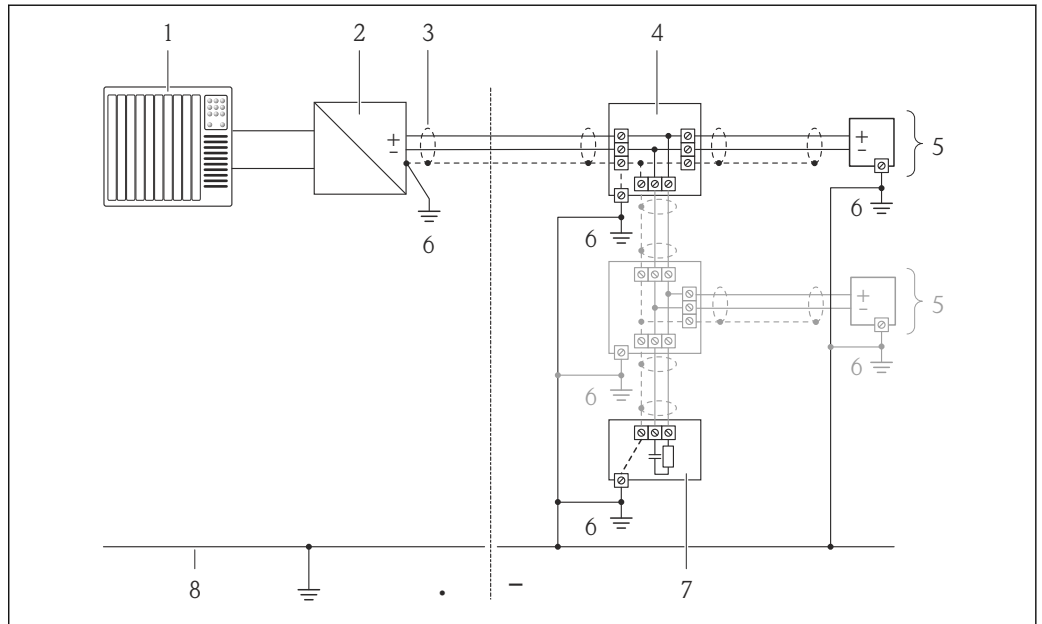

A0019004

10 Connection example for FOUNDATION Fieldbus

- 1 Control system (e.g. PLC)
- 2 Power Conditioner (FOUNDATION Fieldbus)
- 3 Cable shield
- 4 T-box
- 5 Measuring device
- 6 Local grounding
- 7 Bus terminator
- 8 Potential matching line

Current input

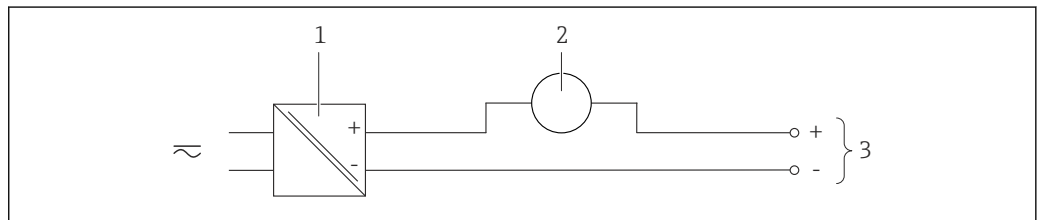

A0020741

11 Connection example for 4-20 mA current input

- 1 Power supply
- 2 External measuring device (for reading in pressure or temperature, for instance)
- 3 Transmitter: observe input values (→ 14)

HART input

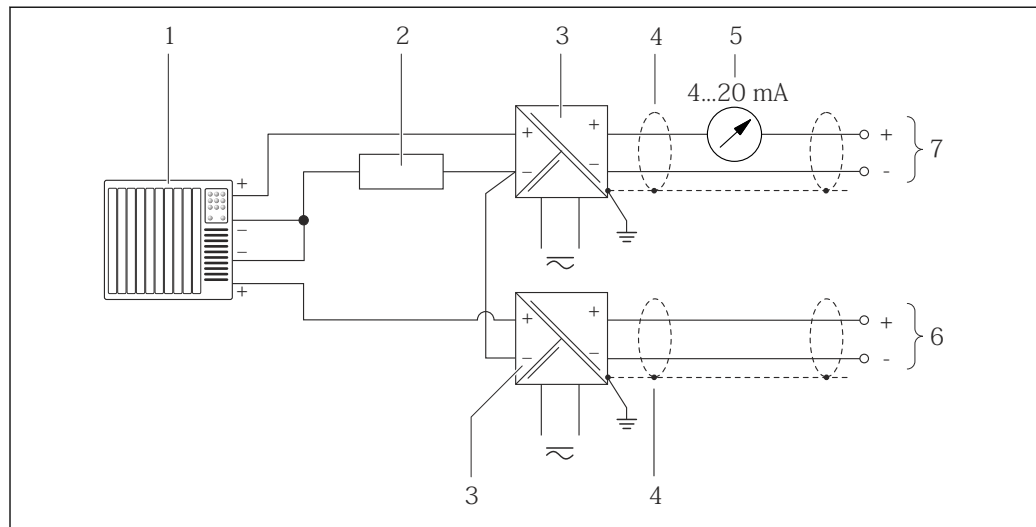

12 Connection example for HART input with a common negative

- 1 Automation system with HART output (e.g. PLC)
- 2 Resistor for HART communication ($\geq 250 \Omega$): observe maximum load (\rightarrow 17)
- 3 Active barrier for power supply (e.g. RN221N) (\rightarrow 31)
- 4 Cable shield, observe cable specifications (\rightarrow 38)
- 5 Analog display unit: observe maximum load (\rightarrow 17)
- 6 Pressure transmitter (e.g. Cerabar M, Cerabar S): see requirements (\rightarrow 13)
- 7 Transmitter

Potential equalization

Requirements

Please consider the following to ensure correct measurement:

- Same electrical potential for the fluid and sensor
- Remote version: same electrical potential for the sensor and transmitter
- Company-internal grounding concepts
- Pipe material and grounding

 For devices intended for use in hazardous locations, please observe the guidelines in the Ex documentation (XA).

Terminals

- For device version without integrated overvoltage protection: plug-in spring terminals for wire cross-sections 0.5 to 2.5 mm² (20 to 14 AWG)
- For device version with integrated overvoltage protection: screw terminals for wire cross-sections 0.2 to 2.5 mm² (24 to 14 AWG)

Cable entries

- Cable gland (not for Ex d): M20 \times 1.5 with cable ϕ 6 to 12 mm (0.24 to 0.47 in)
- Thread for cable entry:
 - For non-Ex and Ex: NPT 1/2"
 - For non-Ex and Ex (not for CSA Ex d/XP): G 1/2"
 - For Ex d: M20 \times 1.5

Cable specification

Permitted temperature range

- -40 °C (-40 °F) to +80 °C (+176 °F)
- Minimum requirement: cable temperature range \geq ambient temperature +20 K

Signal cable

Current output

For 4-20 mA HART: Shielded cable recommended. Observe grounding concept of the plant.

Pulse/frequency/switch output

Standard installation cable is sufficient.

Current input

Standard installation cable is sufficient.

FOUNDATION Fieldbus

Twisted, shielded two-wire cable.



For further information on planning and installing FOUNDATION Fieldbus networks see:

- Operating Instructions for "FOUNDATION Fieldbus Overview" (BA00013S)
- FOUNDATION Fieldbus Guideline
- IEC 61158-2 (MBP)

PROFIBUS PA

Twisted, shielded two-wire cable. Cable type A is recommended.



For further information on planning and installing PROFIBUS PA networks see:

- Operating Instructions "PROFIBUS DP/PA: Guidelines for planning and commissioning" (BA00034S)
- PNO Directive 2.092 "PROFIBUS PA User and Installation Guideline"
- IEC 61158-2 (MBP)

Connecting cable for remote version

Connecting cable (standard)

Standard cable	4 × 2 × 0.34 mm ² (22 AWG) PVC cable with common shield (4 pairs, pair-stranded)
Flame resistance	According to DIN EN 60332-1-2
Oil-resistance	According to DIN EN 60811-2-1
Shielding	Galvanized copper-braid, opt. density approx. 85%
Cable length	5 m (16 ft), 10 m (32 ft), 20 m (65 ft), 30 m (98 ft)
Operating temperature	When mounted in a fixed position: -50 to +105 °C (-58 to +221 °F); when cable can move freely: -25 to +105 °C (-13 to +221 °F)

Connecting cable (reinforced)

Cable, reinforced	4 × 2 × 0.34 mm ² (22 AWG) PVC cable with common shield (4 pairs, pair-stranded) and additional steel-wire braided sheath
Flame resistance	According to DIN EN 60332-1-2
Oil-resistance	According to DIN EN 60811-2-1
Shielding	Galvanized copper-braid, opt. density approx. 85%
Strain relief and reinforcement	Steel-wire braid, galvanized
Cable length	5 m (16 ft), 10 m (32 ft), 20 m (65 ft), 30 m (98 ft)
Operating temperature	When mounted in a fixed position: -50 to +105 °C (-58 to +221 °F); when cable can move freely: -25 to +105 °C (-13 to +221 °F)

Overvoltage protection

The device can be ordered with integrated overvoltage protection for diverse approvals: Order code for "Accessory mounted", option NA "Overvoltage protection"

Input voltage range	Values correspond to supply voltage specifications (→ 31) ¹⁾
Resistance per channel	2 · 0.5 Ω max
DC sparkover voltage	400 to 700 V
Trip surge voltage	<800 V
Capacitance at 1 MHz	<1.5 pF

Nominal discharge current (8/20 μ s)	10 kA
Temperature range	-40 to +85 °C (-40 to +185 °F)

1) The voltage is reduced by the amount of the internal resistance $I_{min} \cdot R_i$

i Depending on the temperature class, restrictions apply to the ambient temperature for device versions with overvoltage protection (\rightarrow 49)

Performance characteristics

Reference operating conditions

- Error limits following ISO/DIN 11631
- +20 to +30 °C (+68 to +86 °F)
- 2 to 4 bar (29 to 58 psi)
- Calibration system traceable to national standards
- Calibration with the process connection corresponding to the particular standard

i To obtain measured errors, use the *Applicator* sizing tool (\rightarrow 94)

Maximum measured error

Base accuracy

o.r. = of reading; o.f.s. = of full scale value, Re = Reynolds number

Volume flow

The measured error for the volume flow is as follows depending on the Reynolds number and the compressibility of the medium under measurement:

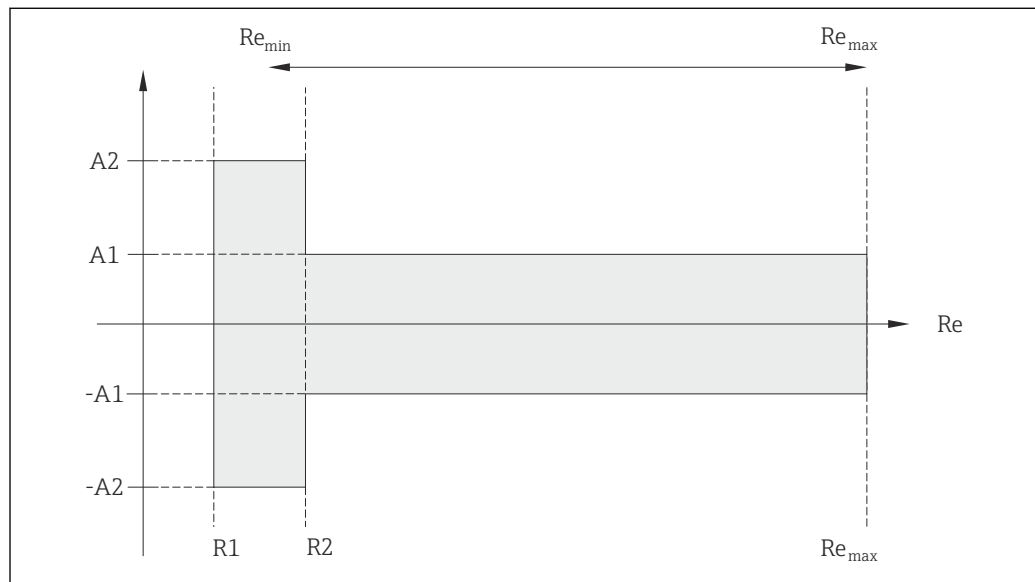

A0019703

Deviation of volume flow value (absolute) from the reading			
Medium type		Incompressible	Compressible ¹⁾
Re range	Measured value deviation	Standard	Standard
R1 to R2	A2	< 10 %	< 10 %
R2 to Re _{max}	A1	< 0.75 %	< 1.0 %

1) Accuracy specifications valid up to 75 m/s (246 ft/s)

Reynolds numbers	Incompressible	Compressible
	Standard	Standard
R1	5 000	
R2	20 000	

Temperature

- Saturated steam and liquids at room temperature if $T > 100\text{ °C}$ (212 °F) applies: $< 1\text{ °C}$ (1.8 °F)
- Gas: $< 1\%$ o.r. [K]

Rise time 50 % (stirred under water, following IEC 60751): 8 s

Mass flow (saturated steam)

- Flow velocities 20 to 50 m/s (66 to 164 ft/s), $T > 150\text{ °C}$ (302 °F) or (423 K)
 - Re $> 20\,000$: $< 1.7\%$ o.r.
 - Re between 5 000 to 20 000: $< 1.7\%$ o.f.s.
- Flow velocities 10 to 70 m/s (33 to 210 ft/s), $T > 140\text{ °C}$ (284 °F) or (413 K)
 - Re $> 20\,000$: $< 2\%$ o.r.
 - Re between 5 000 to 20 000: $< 2\%$ o.f.s.

 The use of a Cerabar S is required for the measured errors listed in the following section. The measured error used to calculate the error in the measured pressure is 0.15%.

Mass flow of superheated steam and gas (single gas, gas mixture, air: NEL40; natural gas: ISO 12213-2 contains AGA8-DC92, AGA NX-19, ISO 12213-3 contains SGERG-88 and AGA8 Gross Method 1)

- Re $> 20\,000$ and process pressure $< 40\text{ bar abs.}$ (580 psi abs.): 1.7 % o.r.
- Re between 5 000 to 20 000 and process pressure $< 40\text{ bar abs.}$ (580 psi abs.): 1.7 % o.f.s.
- Re $> 20\,000$ and process pressure $< 120\text{ bar abs.}$ (1 740 psi abs.): 2.6 % o.r.
- Re between 5 000 to 20 000 and process pressure $< 120\text{ bar abs.}$ (1 740 psi abs.) abs: 2.6 % o.f.s.

abs. = absolute

Mass flow (water)

- Re 20 000: $< 0.85\%$ o.r.
- Re between 5 000 to 20 000: $< 0.85\%$ o.f.s.

Mass flow (user-defined liquids)

To specify the system accuracy, Endress+Hauser requires information about the type of liquid and its operating temperature or information in table form about the dependency between the liquid density and the temperature.

Example

- Acetone is to be measured at fluid temperatures between $+70$ to $+90\text{ °C}$ ($+158$ to $+194\text{ °F}$).
- For this purpose the **Reference temperature** parameter (7703) (here 80 °C (176 °F)), **Reference density** parameter (7700) (here 720.00 kg/m^3) and **Linear expansion coefficient** parameter (7621) (here $18.0298 \times 10^{-4}\text{ 1/°C}$) must be entered in the transmitter.
- The overall system uncertainty, which is smaller than 0.9 % for the example above, is comprised of the following uncertainties of measurement: uncertainty of volume flow measurement, uncertainty of temperature measurement, uncertainty of the density-temperature correlation used (incl. the resulting uncertainty of density).

Mass flow (other media)

Depends on the selected fluid and the pressure value, which is specified in the parameters. Individual error analysis must be performed.

Diameter mismatch correction

Prowirl 200 can correct shifts in the calibration factor which are caused, for example, by diameter mismatch between the device flange (e.g. ASME B16.5/Sch. 80, DN 50 (2")) and the mating pipe (e.g. ASME B16.5/Sch. 40, DN 50 (2")). Only apply diameter mismatch correction within the following limit values (listed below) for which test measurements have also been performed.

Flange connection:

- DN 15 (½"): $\pm 20\%$ of the internal diameter
- DN 25 (1"): $\pm 15\%$ of the internal diameter
- DN 40 (1½"): $\pm 12\%$ of the internal diameter
- DN ≥ 50 (2"): $\pm 10\%$ of the internal diameter

If the standard internal diameter of the ordered process connection differs from the internal diameter of the mating pipe, an additional measuring uncertainty of approx. 2 % o.r. must be expected.

Example

Influence of the diameter mismatch without using the correction function:

- Mating pipe DN 100 (4"), schedule 80
- Device flange DN 100 (4"), schedule 40
- This installation position results in a diameter mismatch of 5 mm (0.2 in). If the correction function is not used, an additional measuring uncertainty of approx. 2 % o.r. must be expected.

 For detailed information about diameter mismatch correction, refer to the Operating Instructions (→  95)

Accuracy of outputs

o.r. = of reading

Current output

Accuracy	±10 µA
----------	--------

Pulse/frequency output

Accuracy	Max. ±100 ppm o.r.
----------	--------------------

Repeatability

o.r. = of reading

±0.2 % o.r.

Response time

If all the configurable functions for filter times (flow damping, display damping, current output time constant, frequency output time constant, status output time constant) are set to 0, in the event of vortex frequencies of 10 Hz and higher a response time of $\max(T_v, 100 \text{ ms})$ can be expected.

In the event of measuring frequencies < 10 Hz, the response time is > 100 ms and can be up to 10 s. T_v is the average vortex period duration of the flowing fluid.

Influence of ambient temperature

o.r. = of reading

Current output

Additional error, in relation to the span of 16 mA:

Temperature coefficient at zero point (4 mA)	0.02 %/10 K
Temperature coefficient with span (20 mA)	0.05 %/10 K

Pulse/frequency output

Temperature coefficient	Max. ±100 ppm o.r.
-------------------------	--------------------

Installation

Mounting location

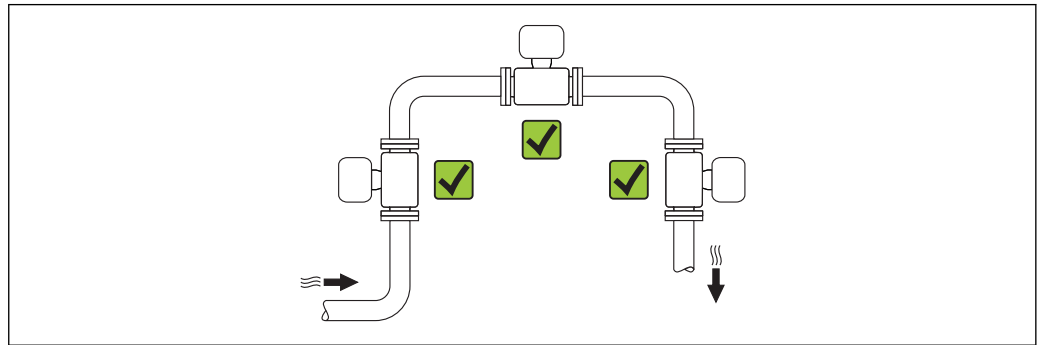

A0015543

Orientation

The direction of the arrow on the sensor nameplate helps you to install the sensor according to the flow direction (direction of medium flow through the piping).

Vortex meters require a fully developed flow profile as a prerequisite for correct volume flow measurement. Therefore, please note the following:

Orientation		Compact version	Remote version
A	Vertical orientation	✓✓ ¹⁾	✓✓
B	Horizontal orientation, transmitter head up	✓✓ ^{2) 3)}	✓✓
C	Horizontal orientation, transmitter head down	✓✓ ^{4) 5)}	✓✓
D	Horizontal orientation, transmitter head at side	✓✓ ⁴⁾	✓✓

- 1) In the case of liquids, there should be upward flow in vertical pipes to avoid partial pipe filling (Fig. A). Disruption in flow measurement! In the case of vertical orientation and downward flowing liquid, the pipe always needs to be completely filled to ensure correct liquid flow measurement.
- 2) Danger of electronics overheating! If the fluid temperature is $\geq 200\text{ °C}$ (392 °F) orientation B is not permitted for the wafer version (Prowirl D) with nominal diameters DN 100 (4") and DN 150 (6").
- 3) In the case of hot media (e.g. steam or fluid temperature (TM) $\geq 200\text{ °C}$ (392 °F): orientation C or D
- 4) In the case of very cold media (e.g. liquid nitrogen): orientation B or D
- 5) For "wet steam detection/measurement" option: orientation C

Minimum spacing and cable length

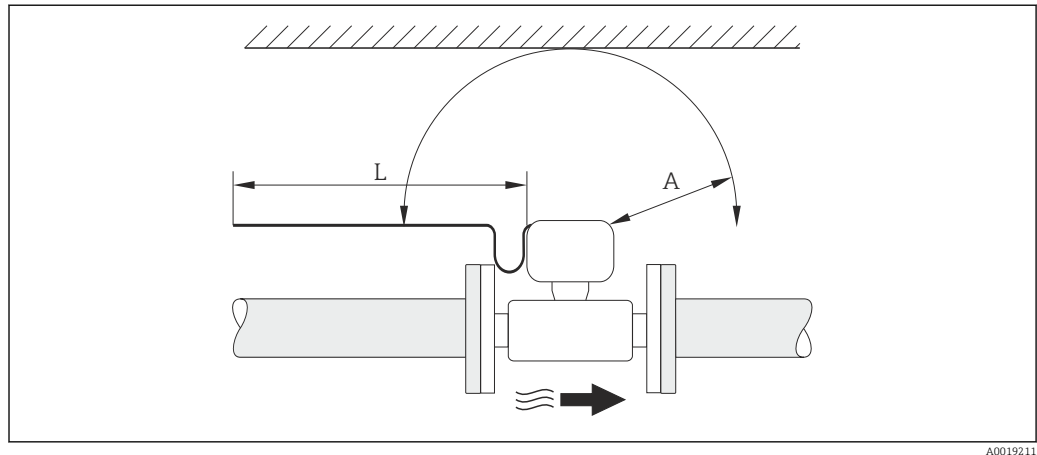

A0019211

- A* Minimum spacing in all directions
L Required cable length

The following dimensions must be observed to guarantee problem-free access to the device for service purposes:

- $A = 100 \text{ mm}$ (3.94 in)
- $L = L + 150 \text{ mm}$ (5.91 in)

Rotating the electronics housing and the display

The electronics housing can be rotated continuously by 360° on the housing support. The display unit can be rotated in 45° stages. This means you can read the display comfortably from all directions.

Inlet and outlet runs

To attain the specified level of accuracy of the measuring device, the inlet and outlet runs mentioned below must be maintained at the very minimum.

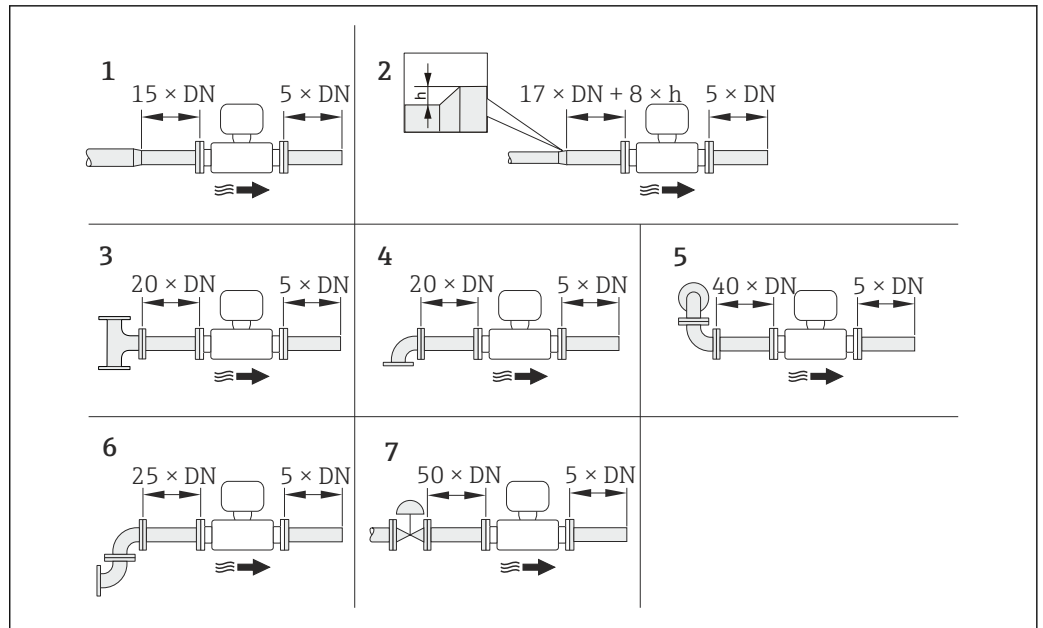

A0019189

13 Minimum inlet and outlet runs with various flow obstructions

h Difference in expansion

1 Reduction by one nominal diameter size

2 Expansion

3 T-piece

4 Single elbow (90° elbow)

5 Double elbow 3D (2 × 90° elbows, opposite, not on one plane)

6 Double elbow (2 × 90° elbows, opposite)

7 Control valve



- If there are several flow disturbances present, the longest specified inlet run must be maintained.
- If the required inlet runs cannot be observed, it is possible to install a specially designed flow conditioner (→ 48).



The **inlet run correction** function:

- Makes it possible to shorten the inlet run to a minimum length of $10 \times DN$ in the event of flow obstructions 1, 4, 5 and 6. An additional measuring uncertainty of $\pm 0.5\%$ o.r. occurs (→ 6).
- Cannot be combined with the **Wet Steam Detection/Measurement** (→ 92) application package. If wet steam detection/measurement is used, the corresponding inlet runs must be taken into consideration. It is not possible to use a flow conditioner for wet steam.

Flow conditioner

If the required inlet runs cannot be observed, it is possible to install a specially designed flow conditioner which can be ordered from Endress+Hauser. The flow conditioner is fitted between two pipe flanges and centered by the mounting bolts. Generally this reduces the inlet run needed to $10 \times DN$ with full accuracy.

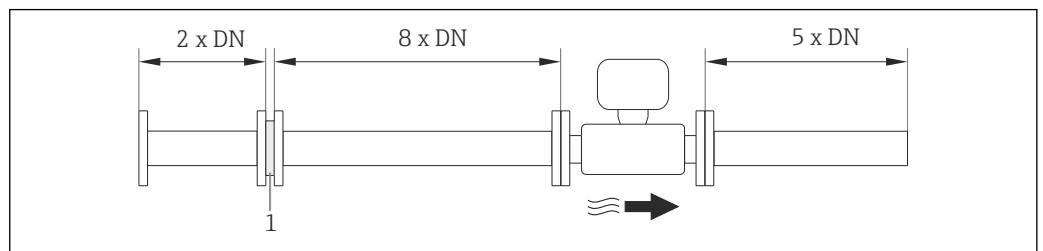

A0019208

1 Flow conditioner

The pressure loss for flow conditioners is calculated as follows: $\Delta p \text{ [mbar]} = 0.0085 \cdot \rho \text{ [kg/m}^3] \cdot v^2 \text{ [m/s]}$

Example for steam

$p = 10 \text{ bar abs.}$

$t = 240 \text{ }^\circ\text{C} \rightarrow \rho = 4.39 \text{ kg/m}^3$

$v = 40 \text{ m/s}$

$\Delta p = 0.0085 \cdot 4.39 \cdot 40^2 = 59.7 \text{ mbar}$

Example for H₂O condensate (80 °C)

$\rho = 965 \text{ kg/m}^3$

$v = 2.5 \text{ m/s}$

$\Delta p = 0.0085 \cdot 965 \cdot 2.5^2 = 51.3 \text{ mbar}$

ρ : density of the process medium

v : average flow velocity

abs. = absolute



For information on the flow conditioner

Outlet runs when installing external devices

If installing an external device, observe the specified distance.

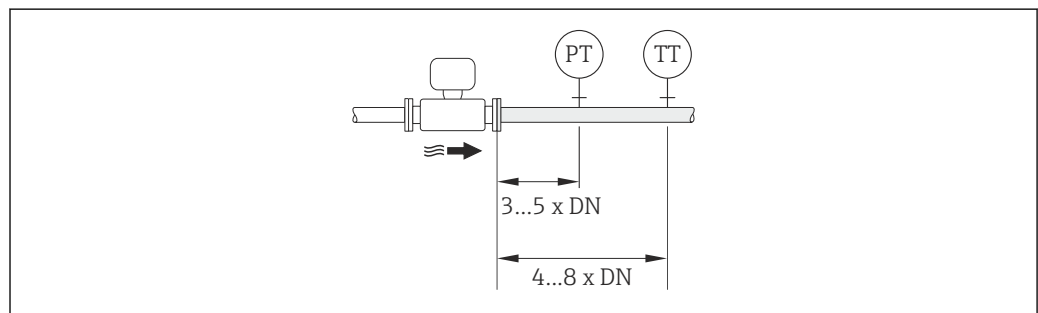

A0019205

PT Pressure transmitter

TT Temperature transmitter

Length of connecting cable

To ensure correct measuring results when using the remote version,

- observe the maximum permitted cable length L_{max} .
- The value for the cable length must be calculated if the cable cross-section differs from the specification.



For detailed information about calculating the length of the connecting cable, refer to the Operating Instructions for the device on the CD-ROM provided

Installing the wall-mount housing

Wall mounting

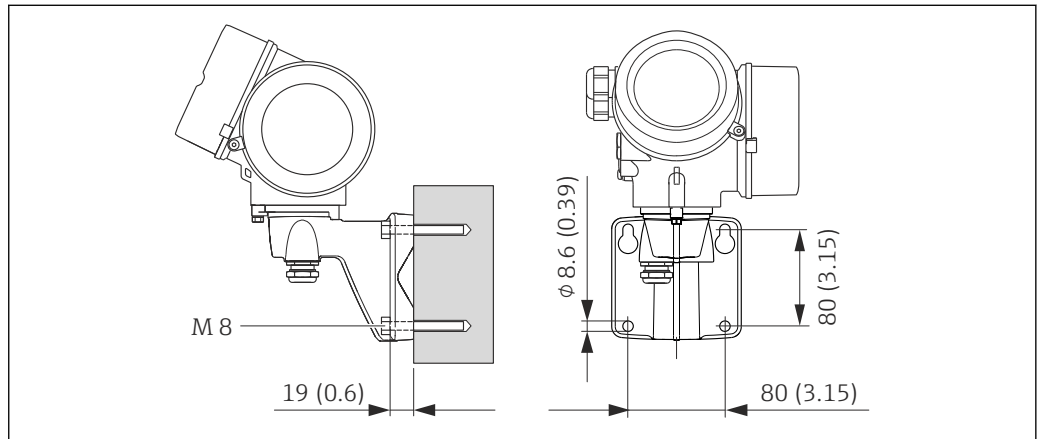

14 Engineering unit mm (in)

A0019864

Post mounting

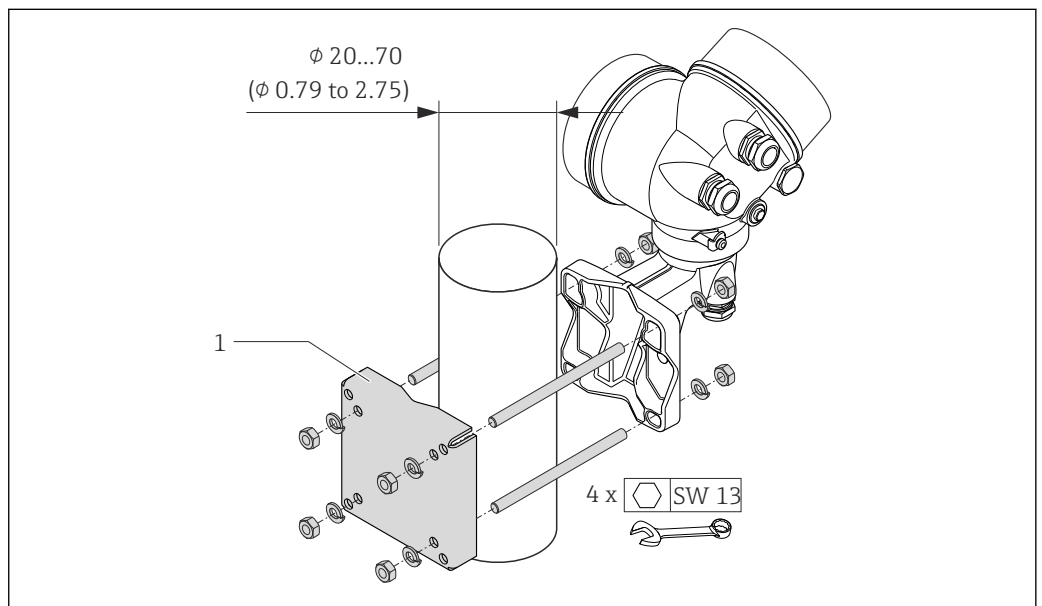

15 Engineering unit mm (in)

A0019862

1 Post retainer kit for post mounting

Special mounting instructions

Installation for delta heat measurements

Order code for "Sensor version", option 3 "Mass flow (integrated temperature measurement)"

The second temperature measurement is taken using a separate temperature sensor. The measuring device reads in this value via a communication interface.

- In the case of saturated steam delta heat measurements, the Prowirl 200 must be installed on the steam side.
- In the case of water delta heat measurements, the Prowirl 200 can be installed on the cold or warm side.

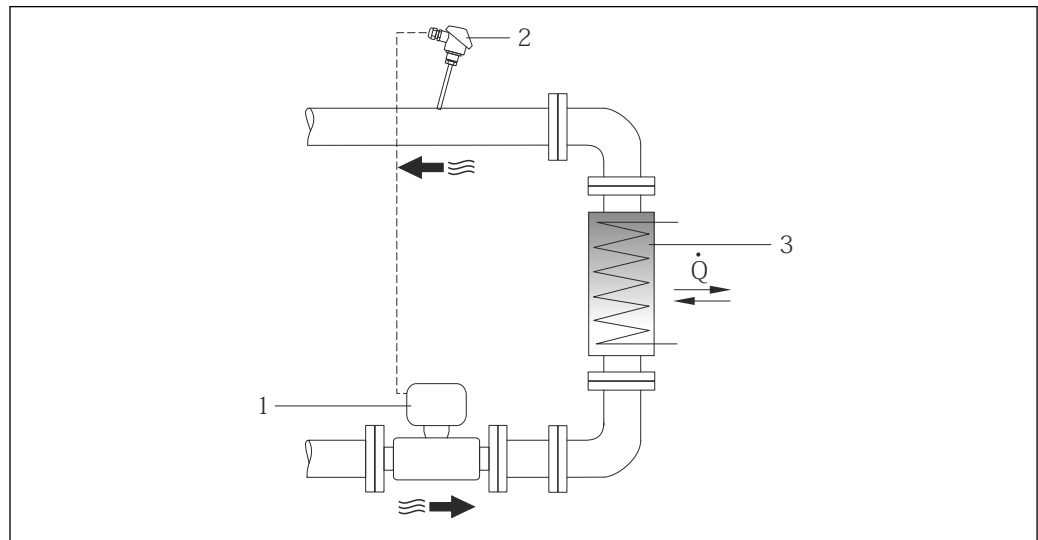



A0019209

16 Layout for delta heat measurement of saturated steam and water

- 1 Prowirl
2 Temperature sensor
3 Heat exchanger
Q Heat flow

Weather protection cover

Observe the following minimum head clearance: 222 mm (8.74 in)

 For information the weather protection cover, see (→  92)

Environment

Ambient temperature range

Compact version

Measuring device	Non-Ex:	-40 to +80 °C (-40 to +176 °F) ¹⁾
	Ex i:	-40 to +70 °C (-40 to +158 °F) ¹⁾
	EEx d/XP version:	-40 to +60 °C (-40 to +140 °F) ¹⁾
	ATEX II1/2G Ex d, Ex ia:	-40 to +60 °C (-40 to +140 °F) ¹⁾
Local display		-20 to +60 °C (-4 to +140 °F)

1) Additionally available as order code for "Test, certificate", option JN "Transmitter ambient temperature -50 °C (-58 °F)".

Remote version

Transmitter	Non-Ex:	-40 to +80 °C (-40 to +176 °F) ¹⁾
	Ex i:	-40 to +80 °C (-40 to +176 °F) ¹⁾
	Ex d:	-40 to +60 °C (-40 to +140 °F) ¹⁾
	ATEX II1/2G Ex d, Ex ia:	-40 to +60 °C (-40 to +140 °F) ¹⁾
Sensor	Non-Ex:	-40 to +85 °C (-40 to +185 °F) ¹⁾
	Ex i:	-40 to +85 °C (-40 to +185 °F) ¹⁾
	Ex d:	-40 to +85 °C (-40 to +185 °F) ¹⁾
	ATEX II1/2G Ex d, Ex ia:	-40 to +85 °C (-40 to +185 °F) ¹⁾
Local display		-20 to +60 °C (-4 to +140 °F)

1) Additionally available as order code for "Test, certificate", option JN "Transmitter ambient temperature -50 °C (-58 °F)".

- ▶ If operating outdoors:
Avoid direct sunlight, particularly in warm climatic regions.

 Weather protection covers can be ordered from Endress+Hauser: see "Accessories" section (→  92)

Temperature tables



T_m = fluid temperature, T_a = ambient temperature

The following interdependencies between the permitted ambient and fluid temperatures apply when operating the device in hazardous areas:

Compact version

Order code for "Sensor version", option 1 "Volume flow, basis"; option 3 "Mass flow (integrated temperature measurement)"

Order code for "Sensor version", option 2 "Volume flow, high-temperature/low-temperature"

 The following temperature tables apply for the low-temperature version (→  49).

Order code for "Output", option A "4-20mA HART"

Order code for "Approval", all options

- Ex d, Ex ia, Ex ic, Ex nA, Ex tb
- $cCSA_{US}$ IS, $cCSA_{US}$ XP, $cCSA_{US}$ NI

SI units

Version with max. $T_m = 280$ °C						
T_a ¹⁾ [°C]	T6 [85 °C]	T5 [100 °C]	T4 [135 °C]	T3 [200 °C]	T2 [300 °C]	T1 [450 °C]
40	80	95	130	195	280	-
60	-	95	130	195	280	-
65	-	-	130	195	280	-
70	-	-	130	-	-	-

1) The following applies for installations with overvoltage protection in conjunction with temperature class T5, T6 and approval options BA, BB, BD, BH, BJ, B2, IA, IB, ID, IH, IJ, I4, C2: $T_a = T_m - 2$ °C

US units

Version with max. $T_m = 536 \text{ }^\circ\text{F}$						
$T_a^{1)}$ [$^\circ\text{F}$]	T6 [185 $^\circ\text{F}$]	T5 [212 $^\circ\text{F}$]	T4 [275 $^\circ\text{F}$]	T3 [392 $^\circ\text{F}$]	T2 [572 $^\circ\text{F}$]	T1 [842 $^\circ\text{F}$]
104	176	203	266	383	536	-
140	-	203	266	383	536	-
149	-	-	266	383	536	-
158	-	-	266	-	-	-

- 1) The following applies for installations with overvoltage protection in conjunction with temperature class T5, T6 and approval options BA, BB, BD, BH, BJ, B2, IA, IB, ID, IH, IJ, I4, C2: $T_a = T_m - 35.6 \text{ }^\circ\text{F}$

Order code for "Output", option B "4-20mA HART, pulse/frequency/switch output"

Order code for "Approval", options BA, BB, BD, BH, BJ, B2, IA, IB, ID, IH, IJ, I4, C2

- Ex ia, Ex ic, Ex tb
- $cCSA_{US}$ IS

SI units

Version with max. $T_m = 280 \text{ }^\circ\text{C}$						
$T_a^{1)}$ [$^\circ\text{C}$]	T6 [85 $^\circ\text{C}$]	T5 [100 $^\circ\text{C}$]	T4 [135 $^\circ\text{C}$]	T3 [200 $^\circ\text{C}$]	T2 [300 $^\circ\text{C}$]	T1 [450 $^\circ\text{C}$]
35 ²⁾	80	95	130	195	280	-
50 ³⁾	-	95	130	195	280	-
60	-	-	130	195	280	-
65	-	-	130	195	280 ⁴⁾	-
70	-	-	130	195 ⁵⁾	280 ⁵⁾	-

- 1) The following applies for installations with overvoltage protection in conjunction with temperature class T5, T6 and approval options BA, BB, BD, BH, BJ, B2, IA, IB, ID, IH, IJ, I4, C2: $T_a = T_m - 2 \text{ }^\circ\text{C}$
- 2) $T_a = 40 \text{ }^\circ\text{C}$ for pulse/frequency/switch output $P_i = 0.85 \text{ W}$
- 3) $T_a = 55 \text{ }^\circ\text{C}$ for pulse/frequency/switch output $P_i = 0.85 \text{ W}$
- 4) $T_a = 65 \text{ }^\circ\text{C}$ for pulse/frequency/switch output $P_i = 0.7 \text{ W}$
- 5) $T_a = 70 \text{ }^\circ\text{C}$ for pulse/frequency/switch output $P_i = 0.7 \text{ W}$

US units

Version with max. $T_m = 536 \text{ }^\circ\text{F}$						
$T_a^{1)}$ [$^\circ\text{F}$]	T6 [185 $^\circ\text{F}$]	T5 [212 $^\circ\text{F}$]	T4 [275 $^\circ\text{F}$]	T3 [392 $^\circ\text{F}$]	T2 [572 $^\circ\text{F}$]	T1 [842 $^\circ\text{F}$]
95 ²⁾	176	203	266	383	536	-
122 ³⁾	-	203	266	383	536	-
140	-	-	266	383	536	-
149	-	-	266	383	536 ⁴⁾	-
158	-	-	266	383 ⁵⁾	536 ⁵⁾	-

- 1) The following applies for installations with overvoltage protection in conjunction with temperature class T5, T6 and approval options BA, BB, BD, BH, BJ, B2, IA, IB, ID, IH, IJ, I4, C2: $T_a = T_m - 35.6 \text{ }^\circ\text{F}$
- 2) $T_a = 104 \text{ }^\circ\text{F}$ for pulse/frequency/switch output $P_i = 0.85 \text{ W}$
- 3) $T_a = 131 \text{ }^\circ\text{F}$ for pulse/frequency/switch output $P_i = 0.85 \text{ W}$
- 4) $T_a = 149 \text{ }^\circ\text{F}$ for pulse/frequency/switch output $P_i = 0.7 \text{ W}$
- 5) $T_a = 158 \text{ }^\circ\text{F}$ for pulse/frequency/switch output $P_i = 0.7 \text{ W}$

Order code for "Approval", options BC, BG, BK, B3, IC, IG, IK, I5, C3

- Ex d, Ex nA, Ex tb
- cCSA_{US} XP

SI units

Version with max. T _m = 280 °C						
T _a [°C]	T6 [85 °C]	T5 [100 °C]	T4 [135 °C]	T3 [200 °C]	T2 [300 °C]	T1 [450 °C]
40	80	95	130	195	280	-
55	-	95	130	195	280	-
65	-	-	130	195	280 ¹⁾	-
70	-	-	130	195 ²⁾	280 ²⁾	-

- 1) T_a = 65 °C for pulse/frequency/switch output P₁ = 0.7 W
- 2) T_a = 70 °C for pulse/frequency/switch output P₁ = 0.7 W

US units

Version with max. T _m = 536 °F						
T _a [°F]	T6 [185 °F]	T5 [212 °F]	T4 [275 °F]	T3 [392 °F]	T2 [572 °F]	T1 [842 °F]
104	176	203	266	383	536	-
131	-	203	266	383	536	-
149	-	-	266	383	536 ¹⁾	-
158	-	-	266	383 ²⁾	536 ²⁾	-

- 1) T_a = 149 °F for pulse/frequency/switch output P₁ = 0.7 W
- 2) T_a = 158 °F for pulse/frequency/switch output P₁ = 0.7 W

Order code for "Output", option C "4-20mA HART, 4-20mA"

Order code for "Approval", all options

- Ex d, Ex ia, Ex ic, Ex nA, Ex tb
- cCSA_{US} IS, cCSA_{US} XP, cCSA_{US} NI

SI units

Version with max. T _m = 280 °C						
T _a ¹⁾ [°C]	T6 [85 °C]	T5 [100 °C]	T4 [135 °C]	T3 [200 °C]	T2 [300 °C]	T1 [450 °C]
40	80	95	130	195	280	-
55	-	95	130	195	280	-
60	-	-	130	195	280	-
65	-	-	130	195	280 ²⁾	-
70	-	-	130	-	-	-

- 1) The following applies for installations with overvoltage protection in conjunction with temperature class T5, T6 and approval options BA, BB, BD, BH, BJ, B2, IA, IB, ID, IH, IJ, I4, C2: T_a = T_a - 2 °C
- 2) T_a = 65 °C for pulse/frequency/switch output P₁ = 0 W

US units

Version with max. $T_m = 536\text{ °F}$						
$T_a^{1)}$ [°F]	T6 [185 °F]	T5 [212 °F]	T4 [275 °F]	T3 [392 °F]	T2 [572 °F]	T1 [842 °F]
104	176	203	266	383	536	-
131	-	203	266	383	536	-
140	-	-	266	383	536	-
149	-	-	266	383	536 ²⁾	-
158	-	-	266	-	-	-

- 1) The following applies for installations with overvoltage protection in conjunction with temperature class T5, T6 and approval options BA, BB, BD, BH, BJ, B2, IA, IB, ID, IH, IJ, I4, C2: $T_a = T_m - 35.6\text{ °F}$
- 2) $T_a = 149\text{ °F}$ for pulse/frequency/switch output $P_1 = 0\text{ W}$

Order code for "Output", option D "4-20 mA HART, PFS output; 4-20 mA input"

Order code for "Approval", all options

- Ex d, Ex ia, Ex ic, Ex nA, Ex tb
- cCSA_{US} IS, cCSA_{US} XP, cCSA_{US} NI

SI units

Version with max. $T_m = 280\text{ °C}$						
$T_a^{1)}$ [°C]	T6 [85 °C]	T5 [100 °C]	T4 [135 °C]	T3 [200 °C]	T2 [300 °C]	T1 [450 °C]
35	80	95	130	195	280	-
50	-	95	130	195	280	-
55	-	-	-	195	280	-
60	-	-	-	195	-	-

- 1) The following applies for installations with overvoltage protection in conjunction with temperature class T5, T6 and approval options BA, BB, BD, BH, BJ, B2, IA, IB, ID, IH, IJ, I4, C2: $T_a = T_m - 2\text{ °C}$

US units

Version with max. $T_m = 536\text{ °F}$						
$T_a^{1)}$ [°F]	T6 [185 °F]	T5 [212 °F]	T4 [275 °F]	T3 [392 °F]	T2 [572 °F]	T1 [842 °F]
95	176	203	266	383	536	-
122	-	203	266	383	536	-
131	-	-	-	383	536	-
140	-	-	-	383	-	-

- 1) The following applies for installations with overvoltage protection in conjunction with temperature class T5, T6 and approval options BA, BB, BD, BH, BJ, B2, IA, IB, ID, IH, IJ, I4, C2: $T_a = T_m - 35.6\text{ °F}$

Order code for "Output", option E "FOUNDATION Fieldbus, pulse/frequency/switch output" and option G "PROFIBUS PA, pulse/frequency/switch output"

Order code for "Approval", all options

- Ex d, Ex ia, Ex ic, Ex nA, Ex tb
- cCSA_{US} IS, cCSA_{US} XP, cCSA_{US} NI

SI units

Version with max. T _m = 280 °C						
T _a ¹⁾ [°C]	T6 [85 °C]	T5 [100 °C]	T4 [135 °C]	T3 [200 °C]	T2 [300 °C]	T1 [450 °C]
40	80	95	130	195	280	-
50 ²⁾	-	95	130	195	280	-
60	-	-	130	195	280	-
65	-	-	130	195	280 ³⁾	-
70	-	-	130	195 ⁴⁾	280 ⁴⁾	-

- 1) The following applies for installations with overvoltage protection in conjunction with temperature class T5, T6 and approval options BA, BB, BD, BH, BJ, B2, IA, IB, ID, IH, IJ, I4, C2: T_a = T_a - 2 °C
- 2) T_a = 60 °C for pulse/frequency/switch output P_i = 0 W
- 3) T_a = 65 °C for pulse/frequency/switch output P_i = 0 W
- 4) T_a = 70 °C for pulse/frequency/switch output P_i = 0 W



US units

Version with max. T _m = 536 °F						
T _a ¹⁾ [°F]	T6 [185 °F]	T5 [212 °F]	T4 [275 °F]	T3 [392 °F]	T2 [572 °F]	T1 [842 °F]
104	176	203	266	383	536	-
122 ²⁾	-	203	266	383	536	-
140	-	-	266	383	536	-
149	-	-	266	383	536 ³⁾	-
158	-	-	266	383 ⁴⁾	536 ⁴⁾	-

- 1) The following applies for installations with overvoltage protection in conjunction with temperature class T5, T6 and approval options BA, BB, BD, BH, BJ, B2, IA, IB, ID, IH, IJ, I4, C2: T_a = T_a - 35.6 °F
- 2) T_a = 140 °F for pulse/frequency/switch output P_i = 0 W
- 3) T_a = 149 °F for pulse/frequency/switch output P_i = 0 W
- 4) T_a = 158 °F for pulse/frequency/switch output P_i = 0 W

High-temperature version

Order code for "Sensor version", option 2 "Volume flow, high-temperature/low-temperature"

 The following temperature tables apply for the high-temperature version (→  54).

Order code for "Output", option A "4-20mA HART"

Order code for "Approval", all options

- Ex d, Ex ia, Ex ic, Ex nA, Ex tb
- cCSA_{US} IS, cCSA_{US} XP, cCSA_{US} NI

SI units

Version with max. $T_m = 440\text{ °C}$						
$T_a^{1)}$ [°C]	T6 [85 °C]	T5 [100 °C]	T4 [135 °C]	T3 [200 °C]	T2 [300 °C]	T1 [450 °C]
40	80	95	130	195	290	440
60	-	95	130	195	290	440
70	-	-	130	195	290	440

- 1) The following applies for installations with overvoltage protection in conjunction with temperature class T5, T6 and approval options BA, BB, BD, BH, BJ, B2, IA, IB, ID, IH, IJ, I4, C2: $T_a = T_m - 2\text{ °C}$

US units

Version with max. $T_m = 824\text{ °F}$						
$T_a^{1)}$ [°F]	T6 [185 °F]	T5 [212 °F]	T4 [275 °F]	T3 [392 °F]	T2 [572 °F]	T1 [842 °F]
104	176	203	266	383	554	824
140	-	203	266	383	554	824
158	-	-	266	383	554	824

- 1) The following applies for installations with overvoltage protection in conjunction with temperature class T5, T6 and approval options BA, BB, BD, BH, BJ, B2, IA, IB, ID, IH, IJ, I4, C2: $T_a = T_m - 35.6\text{ °F}$

Order code for "Output", option B "4-20mA HART, pulse/frequency/switch output"

Order code for "Approval", options BA, BB, BD, BH, BJ, B2, IA, IB, ID, IH, IJ, I4, C2

- Ex ia, Ex ic, Ex tb
- cCSA_{US} IS

SI units

Version with max. $T_m = 440\text{ °C}$						
$T_a^{1)}$ [°C]	T6 [85 °C]	T5 [100 °C]	T4 [135 °C]	T3 [200 °C]	T2 [300 °C]	T1 [450 °C]
35 ²⁾	80	95	130	195	290	440
50 ³⁾	-	95	130	195	290	440
65	-	-	130	195	290	440
70	-	-	130	195 ⁴⁾	290	440 ⁴⁾

- 1) The following applies for installations with overvoltage protection in conjunction with temperature class T5, T6 and approval options BA, BB, BD, BH, BJ, B2, IA, IB, ID, IH, IJ, I4, C2: $T_a = T_m - 2\text{ °C}$
- 2) $T_a = 40\text{ °C}$ for pulse/frequency/switch output $P_i = 0.85\text{ W}$
- 3) $T_a = 55\text{ °C}$ for pulse/frequency/switch output $P_i = 0.85\text{ W}$
- 4) $T_a = 70\text{ °C}$ for pulse/frequency/switch output $P_i = 0.85\text{ W}$

US units

Version with max. $T_m = 824\text{ °F}$						
T_a ¹⁾ [°F]	T6 [185 °F]	T5 [212 °F]	T4 [275 °F]	T3 [392 °F]	T2 [572 °F]	T1 [842 °F]
95 ²⁾	176	203	266	383	554	824
122 ³⁾	-	203	266	383	554	824
149	-	-	266	383	554	824
158	-	-	266	383 ⁴⁾	554	824 ⁴⁾

- 1) The following applies for installations with overvoltage protection in conjunction with temperature class T5, T6 and approval options BA, BB, BD, BH, BJ, B2, IA, IB, ID, IH, IJ, I4, C2: $T_a = T_m - 35.6\text{ °F}$
- 2) $T_a = 104\text{ °F}$ for pulse/frequency/switch output $P_i = 0.85\text{ W}$
- 3) $T_a = 131\text{ °F}$ for pulse/frequency/switch output $P_i = 0.85\text{ W}$
- 4) $T_a = 158\text{ °F}$ for pulse/frequency/switch output $P_i = 0.85\text{ W}$

Order code for "Approval", options BC, BG, BK, B3, IC, IG, IK, I5, C3

- Ex d, Ex nA, Ex tb
- cCSA_{US} XP

SI units

Version with max. $T_m = 440\text{ °C}$						
T_a [°C]	T6 [85 °C]	T5 [100 °C]	T4 [135 °C]	T3 [200 °C]	T2 [300 °C]	T1 [450 °C]
40	80	95	130	195	290	440
55	-	95	130	195	290	440
65	-	-	130	195	290	440
70	-	-	130	195 ¹⁾	290 ¹⁾	440 ¹⁾

- 1) $T_a = 70\text{ °C}$ for pulse/frequency/switch output $P_i = 0.85\text{ W}$

US units

Version with max. $T_m = 824\text{ °F}$						
T_a [°F]	T6 [185 °F]	T5 [212 °F]	T4 [275 °F]	T3 [392 °F]	T2 [572 °F]	T1 [842 °F]
104	176	203	266	383	554	824
131	-	203	266	383	554	824
149	-	-	266	383	554	824
158	-	-	266	383 ¹⁾	554 ¹⁾	824 ¹⁾

- 1) $T_a = 158\text{ °F}$ for pulse/frequency/switch output $P_i = 0.85\text{ W}$

Order code for "Output", option C "4-20mA HART, 4-20mA"

Order code for "Approval", all options

- Ex d, Ex ia, Ex ic, Ex nA, Ex tb
- cCSA_{US} IS, cCSA_{US} XP, cCSA_{US} NI

SI units

Version with max. $T_m = 440\text{ °C}$						
$T_a^{1)}$ [°C]	T6 [85 °C]	T5 [100 °C]	T4 [135 °C]	T3 [200 °C]	T2 [300 °C]	T1 [450 °C]
40	80	95	130	195	290	440
55	-	95	130	195	290	440
65	-	-	130	195	290	440
70	-	-	130	195 ²⁾	290 ²⁾	440 ²⁾

- 1) The following applies for installations with overvoltage protection in conjunction with temperature class T5, T6 and approval options BA, BB, BD, BH, BJ, B2, IA, IB, ID, IH, IJ, I4, C2: $T_a = T_m - 2\text{ °C}$
- 2) $T_a = 70\text{ °C}$ for pulse/frequency/switch output $P_i = 0\text{ W}$

US units

Version with max. $T_m = 824\text{ °F}$						
$T_a^{1)}$ [°F]	T6 [185 °F]	T5 [212 °F]	T4 [275 °F]	T3 [392 °F]	T2 [572 °F]	T1 [842 °F]
104	176	203	266	383	554	824
131	-	203	266	383	554	824
149	-	-	266	383	554	824
158	-	-	266	383 ²⁾	554 ²⁾	824 ²⁾

- 1) The following applies for installations with overvoltage protection in conjunction with temperature class T5, T6 and approval options BA, BB, BD, BH, BJ, B2, IA, IB, ID, IH, IJ, I4, C2: $T_a = T_m - 35.6\text{ °F}$
- 2) $T_a = 158\text{ °F}$ for pulse/frequency/switch output $P_i = 0\text{ W}$

Order code for "Output", option D "4-20 mA HART, PFS output; 4-20 mA input"

Order code for "Approval", all options

- Ex d, Ex ia, Ex ic, Ex nA, Ex tb
- cCSA_{US} IS, cCSA_{US} XP, cCSA_{US} NI

SI units

Version with max. $T_m = 440\text{ °C}$						
$T_a^{1)}$ [°C]	T6 [85 °C]	T5 [100 °C]	T4 [135 °C]	T3 [200 °C]	T2 [300 °C]	T1 [450 °C]
35	80	95	130	195	290	440
50	-	95	130	195	290	440
55	-	-	-	195	290	440
60	-	-	-	195	290	440
65	-	-	-	-	290	-

- 1) The following applies for installations with overvoltage protection in conjunction with temperature class T5, T6 and approval options BA, BB, BD, BH, BJ, B2, IA, IB, ID, IH, IJ, I4, C2: $T_a = T_m - 2\text{ °C}$

US units

Version with max. $T_m = 824 \text{ }^\circ\text{F}$						
$T_a^{1)}$ [$^\circ\text{F}$]	T6 [185 $^\circ\text{F}$]	T5 [212 $^\circ\text{F}$]	T4 [275 $^\circ\text{F}$]	T3 [392 $^\circ\text{F}$]	T2 [572 $^\circ\text{F}$]	T1 [842 $^\circ\text{F}$]
95	176	203	266	383	554	824
122	-	203	266	383	554	824
131	-	-	-	383	554	824
140	-	-	-	383	554	824
149	-	-	-	-	554	-

- 1) The following applies for installations with overvoltage protection in conjunction with temperature class T5, T6 and approval options BA, BB, BD, BH, BJ, B2, IA, IB, ID, IH, IJ, I4, C2: $T_a = T_a - 35.6 \text{ }^\circ\text{F}$

Order code for "Output", option E "FOUNDATION Fieldbus, pulse/frequency/switch output" and option G "PROFIBUS PA, pulse/frequency/switch output"

Order code for "Approval", all options

- Ex d, Ex ia, Ex ic, Ex nA, Ex tb
- cCSA_{US} IS, cCSA_{US} XP, cCSA_{US} NI

SI units

Version with max. $T_m = 440 \text{ }^\circ\text{C}$						
$T_a^{1)}$ [$^\circ\text{C}$]	T6 [85 $^\circ\text{C}$]	T5 [100 $^\circ\text{C}$]	T4 [135 $^\circ\text{C}$]	T3 [200 $^\circ\text{C}$]	T2 [300 $^\circ\text{C}$]	T1 [450 $^\circ\text{C}$]
40	80	95	130	195	290	440
50 ²⁾	-	95	130	195	290	440
65	-	-	130	195	290	440
70	-	-	130	195 ³⁾	290 ³⁾	440 ³⁾

- 1) The following applies for installations with overvoltage protection in conjunction with temperature class T5, T6 and approval options BA, BB, BD, BH, BJ, B2, IA, IB, ID, IH, IJ, I4, C2: $T_a = T_a - 2 \text{ }^\circ\text{C}$
- 2) $T_a = 60 \text{ }^\circ\text{C}$ for pulse/frequency/switch output $P_i = 0 \text{ W}$
- 3) $T_a = 70 \text{ }^\circ\text{C}$ for pulse/frequency/switch output $P_i = 0 \text{ W}$

US units

Version with max. $T_m = 824 \text{ }^\circ\text{F}$						
$T_a^{1)}$ [$^\circ\text{F}$]	T6 [185 $^\circ\text{F}$]	T5 [212 $^\circ\text{F}$]	T4 [275 $^\circ\text{F}$]	T3 [392 $^\circ\text{F}$]	T2 [572 $^\circ\text{F}$]	T1 [842 $^\circ\text{F}$]
104	176	203	266	383	554	824
122 ²⁾	-	203	266	383	554	824
149	-	-	266	383	554	824
158	-	-	266	383 ³⁾	554 ³⁾	824 ³⁾

- 1) The following applies for installations with overvoltage protection in conjunction with temperature class T5, T6 and approval options BA, BB, BD, BH, BJ, B2, IA, IB, ID, IH, IJ, I4, C2: $T_a = T_a - 35.6 \text{ }^\circ\text{F}$
- 2) $T_a = 140 \text{ }^\circ\text{F}$ for pulse/frequency/switch output $P_i = 0 \text{ W}$
- 3) $T_a = 158 \text{ }^\circ\text{F}$ for pulse/frequency/switch output $P_i = 0 \text{ W}$

*Remote version**Transmitter*

Order code for "Housing", option J "GT20 two-chamber, remote G314, aluminum coated"; option K "GT20 two-chamber, remote G315, 316L"

SI units

Order code for "Output", option	Order code for "Approval", option	T6 [85 °C]	T5 [100 °C]	T4 [135 °C]
A	All	40	60	75
B	BA, BB, BD, BH, BJ, B2, IA, IB, ID, IH, IJ, I4, C2	35 ¹⁾	50 ²⁾	70 ³⁾
	BC, BG, BK, B3, IC, IG, IK, I5, C3	40	55	70 ³⁾
C	All	40	55	70 ⁴⁾
D	All	35 ⁵⁾	50 ⁵⁾	65
E G	All	40	55	70 ⁴⁾

- 1) $T_a = 40\text{ °C}$ for pulse/frequency/switch output $P_i = 0.85\text{ W}$
- 2) $T_a = 60\text{ °C}$ for pulse/frequency/switch output $P_i = 0.85\text{ W}$
- 3) $T_a = 75\text{ °C}$ for pulse/frequency/switch output $P_i = 0.85\text{ W}$
- 4) $T_a = 75\text{ °C}$ for pulse/frequency/switch output $P_i = 0\text{ W}$
- 5) The following applies for installations with overvoltage protection in conjunction with temperature class T5, T6 and approval options BA, BB, BD, BH, BJ, B2, IA, IB, ID, IH, IJ, I4, C2: $T_a = T_a - 2\text{ °C}$

US units



Order code for "Output", option	Order code for "Approval", option	T6 [185 °F]	T5 [212 °F]	T4 [275 °F]
A	All	104	140	167
B	BA, BB, BD, BH, BJ, B2, IA, IB, ID, IH, IJ, I4, C2	95 ¹⁾	122 ²⁾	158 ³⁾
	BC, BG, BK, B3, IC, IG, IK, I5, C3	104	131	158 ³⁾
C	All	104	131	158 ⁴⁾
D	All	95 ⁵⁾	122 ⁵⁾	149
E G	All	104	131	158 ⁴⁾

- 1) $T_a = 104\text{ °F}$ for pulse/frequency/switch output $P_i = 0.85\text{ W}$
- 2) $T_a = 140\text{ °F}$ for pulse/frequency/switch output $P_i = 0.85\text{ W}$
- 3) $T_a = 167\text{ °F}$ for pulse/frequency/switch output $P_i = 0.85\text{ W}$
- 4) $T_a = 167\text{ °F}$ for pulse/frequency/switch output $P_i = 0\text{ W}$
- 5) The following applies for installations with overvoltage protection in conjunction with temperature class T5, T6 and approval options BA, BB, BD, BH, BJ, B2, IA, IB, ID, IH, IJ, I4, C2: $T_a = T_a - 35.6\text{ °F}$

Sensor

Order code for "Sensor version", option 1 "Volume flow, basis"; option 3 "Mass flow (integrated temperature measurement)"

Order code for "Sensor version", option 2 "Volume flow, high-temperature/low-temperature"

 The following temperature tables apply for the low-temperature version (→  59).

SI units

Version with max. $T_m = 280\text{ °C}$						
T_a [°C]	T6 [85 °C]	T5 [100 °C]	T4 [135 °C]	T3 [200 °C]	T2 [300 °C]	T1 [450 °C]
55	80	95	130	195	280	–
70	–	95	130	195	280	–
85	–	–	130	195	280	–

US units

Version with max. $T_m = 536\text{ °F}$						
T_a [°F]	T6 [185 °F]	T5 [212 °F]	T4 [275 °F]	T3 [392 °F]	T2 [572 °F]	T1 [842 °F]
104	176	203	266	383	536	–
122	–	203	266	383	536	–
149	–	–	266	383	536	–

High-temperature version

Order code for "Sensor version", option 2 "Volume flow, high-temperature/low-temperature"

 The following temperature tables apply for the high-temperature version (→  59).

SI units

Version with max. $T_m = 440\text{ °C}$						
T_a [°C]	T6 [85 °C]	T5 [100 °C]	T4 [135 °C]	T3 [200 °C]	T2 [300 °C]	T1 [450 °C]
55	80	95	130	195	290	440
70	–	95	130	195	290	440
85	–	–	130	195	290	440

US units

Version with max. $T_m = 824\text{ °F}$						
T_a [°F]	T6 [185 °F]	T5 [212 °F]	T4 [275 °F]	T3 [392 °F]	T2 [572 °F]	T1 [842 °F]
131	176	203	266	383	554	824
158	–	203	266	383	554	824
185	–	–	266	383	554	824

Storage temperature

All components apart from the display modules:
–50 to +80 °C (–58 to +176 °F)

Display modules:
–40 to +80 °C (–40 to +176 °F)

Climate class

DIN EN 60068-2-38 (test Z/AD)

Degree of protection	<p>Transmitter</p> <ul style="list-style-type: none"> ■ As standard: IP66/67, type 4X enclosure ■ When housing is open: IP20, type 1 enclosure ■ Display module: IP20, type 1 enclosure <p>Sensor IP66/67, type 4X enclosure</p> <p>Device plug IP67, only in screwed situation</p>
Vibration resistance	<ul style="list-style-type: none"> ■ For compact/remote version made of coated aluminum and remote version made of stainless steel: Acceleration up to 2g (if gain set to factory setting), 10 to 500 Hz, following IEC 60068-2-6 ■ For the compact version made of stainless steel: Acceleration up to 1g (if gain set to factory setting), 10 to 500 Hz, following IEC 60068-2-6
Electromagnetic compatibility (EMC)	<p>As per IEC/EN 61326 and NAMUR Recommendation 21 (NE 21)</p> <p> For details refer to the Declaration of Conformity.</p>

Process

Medium temperature range	<p>DSC sensor³⁾ Order code for "Sensor version":</p> <ul style="list-style-type: none"> ■ Option 1 "Volume flow, basis": -40 to +260 °C (-40 to +500 °F), stainless steel ■ Option 2 "Volume flow, high-temperature/low temperature": -200 to +400 °C (-328 to +752 °F), stainless steel ■ Option 3 "Mass flow (integrated temperature measurement)": -200 to +400 °C (-328 to +752 °F), stainless steel <p>DSC sensor³⁾ Order code for "Sensor option":</p> <ul style="list-style-type: none"> ■ Option CD "Harsh environment, DSC sensor components, Alloy C22": -200 to +400 °C (-328 to +752 °F), DSC sensor Alloy C22 ■ Option CE "Harsh process, wetted parts, Alloy C22, (including option CD)": -40 to +260 °C (-40 to +500 °F), sensor and DSC sensor Alloy C22 <p>DSC sensor³⁾ <i>Special version for very high fluid temperatures (on request):</i></p> <ul style="list-style-type: none"> ■ -200 to +450 °C (-328 to +842 °F) ■ -200 to +440 °C (-328 to +824 °F), Ex version ■ <p>Seals</p> <ul style="list-style-type: none"> ■ -200 to +400 °C (-328 to +752 °F) for graphite (standard) ■ -15 to +175 °C (+5 to +347 °F) for Viton ■ -20 to +275 °C (-4 to +527 °F) for Kalrez ■ -200 to +260 °C (-328 to +500 °F) for Gylon
---------------------------------	---

Pressure-temperature ratings	<p>The following pressure-temperature ratings refer to the entire device and not just the process connection.</p> <p>The pressure-temperature rating for the specific measuring device is programmed into the software. If values exceed the curve range a warning is displayed. Depending on the system configuration and sensor version, the pressure and temperature are determined by entering, reading in or calculating values.</p>
-------------------------------------	---

3) Capacitance sensor

Process connection: flange to EN 1092-1 (DIN 2501)

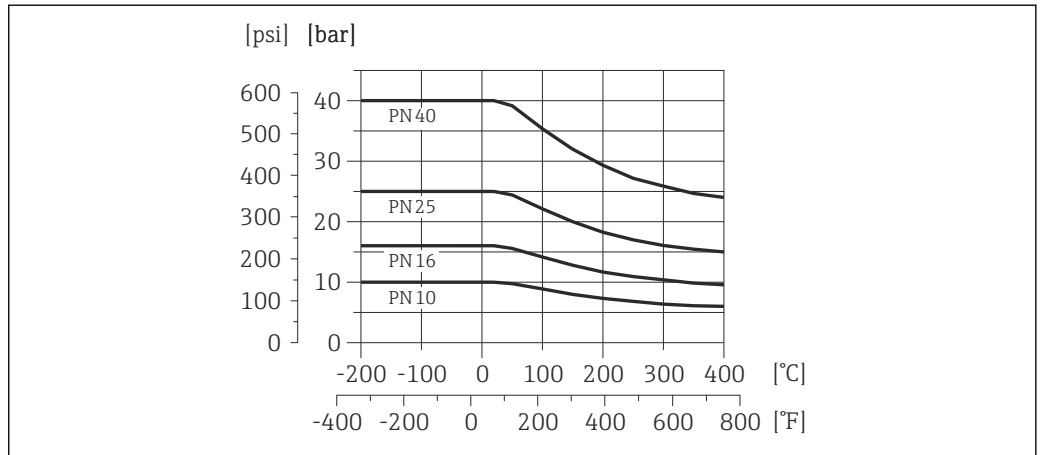

17 Process connection material: stainless steel, multiple certifications, 1.4404 (F316, F316L)

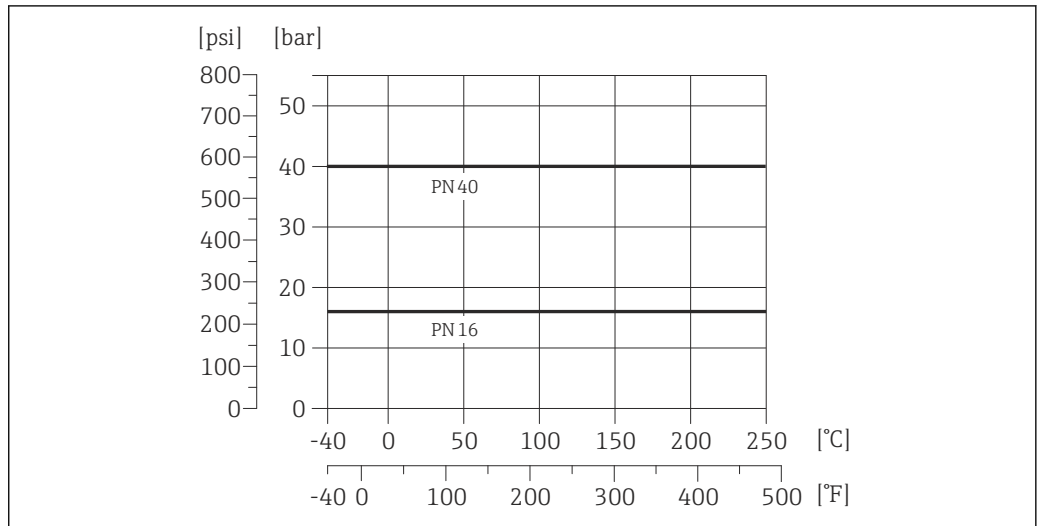

18 Process connection material: cast alloy CX2MW similar to Alloy C22/2.4602

Process connection: flange to ASME B16.5

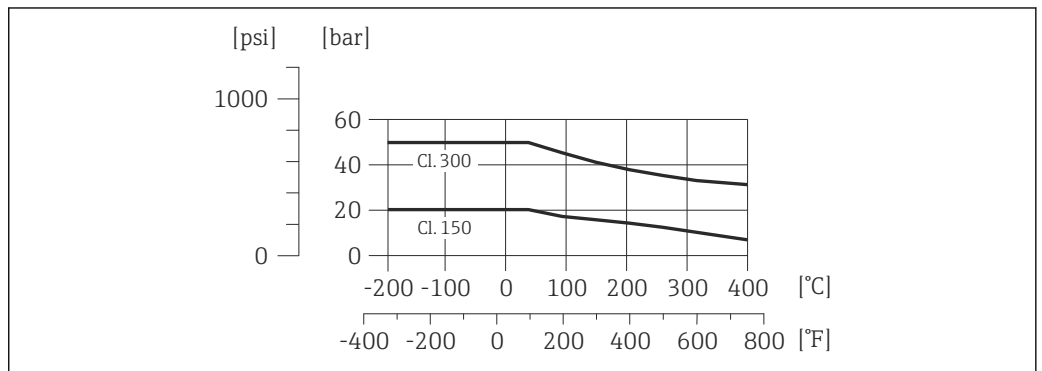

19 Process connection material: stainless steel, multiple certifications, 1.4404 (F316, F316L)

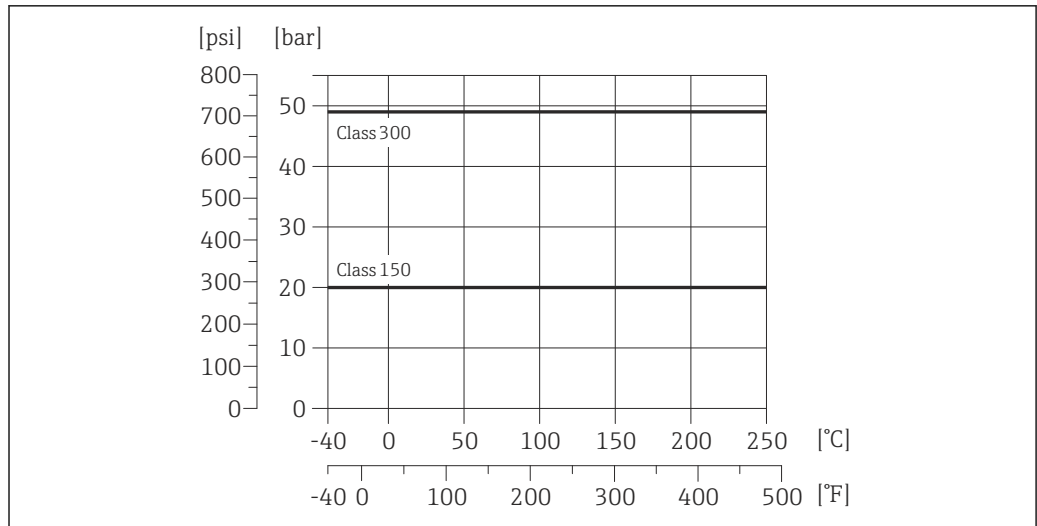

A0020876-EN

20 Process connection material: cast alloy CX2MW similar to Alloy C22/2.4602

Process connection: flange to JIS B2220

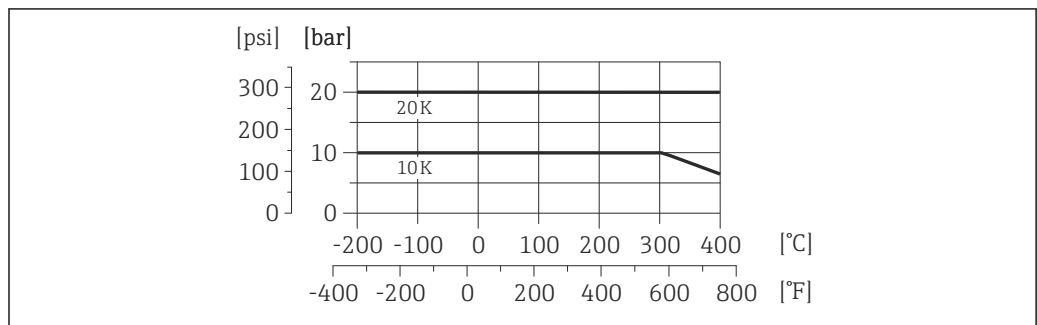

A0020881-EN

21 Process connection material: stainless steel, multiple certifications, 1.4404 (F316, F316L)

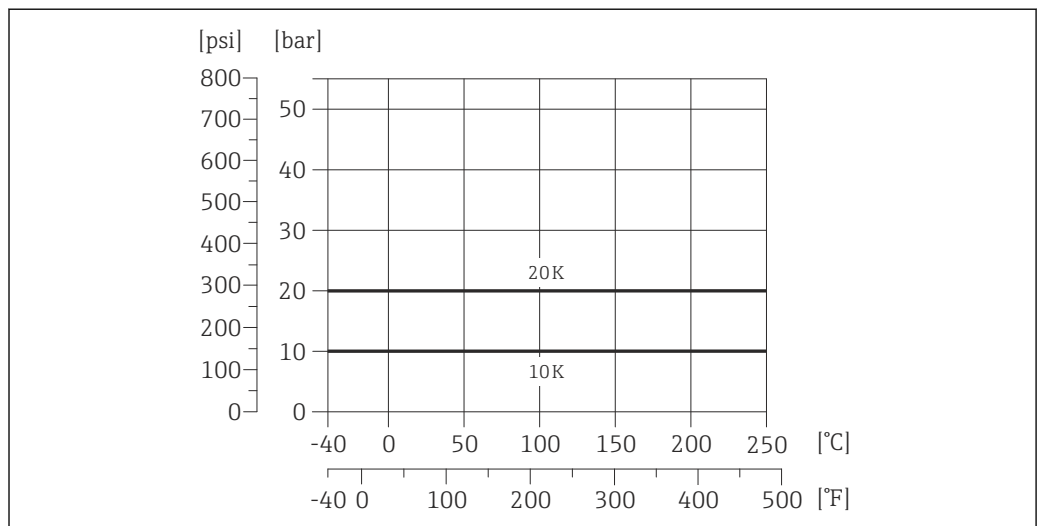

A0020877-EN

22 Process connection material: cast alloy CX2MW similar to Alloy C22/2.4602

Pressure loss

For a precise calculation, use the Applicator(→ 94).

Thermal insulation

For optimum temperature measurement and mass calculation, heat transfer at the sensor must be avoided for some fluids. This can be ensured by installing thermal insulation. A wide range of materials can be used for the required insulation.

- This applies for:
- Compact version
 - Remote sensor version

The maximum insulation height permitted is illustrated in the diagram:

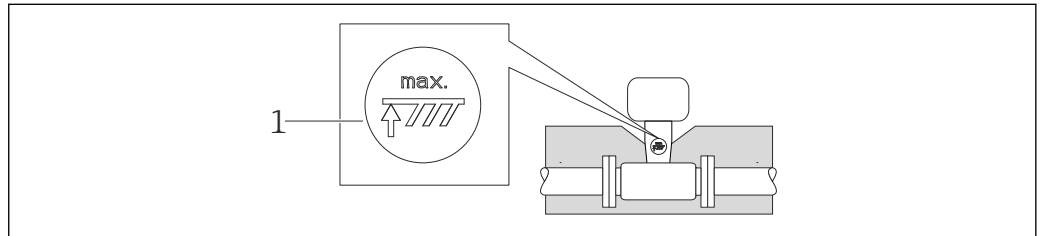

A0019212

1 Maximum insulation height

- ▶ When insulating, ensure that a sufficiently large area of the housing support remains exposed. The uncovered part serves as a radiator and protects the electronics from overheating and excessive cooling.

Vibrations

The correct operation of the measuring system is not affected by plant vibrations up to 1 g, 10 to 500 Hz. Therefore no special measures are needed to secure the sensors.

Mechanical construction

Design, dimensions

Compact version

Order code for "Housing", option B "GT18 two-chamber, 316L"; option C "GT20 two-chamber, aluminum coated"

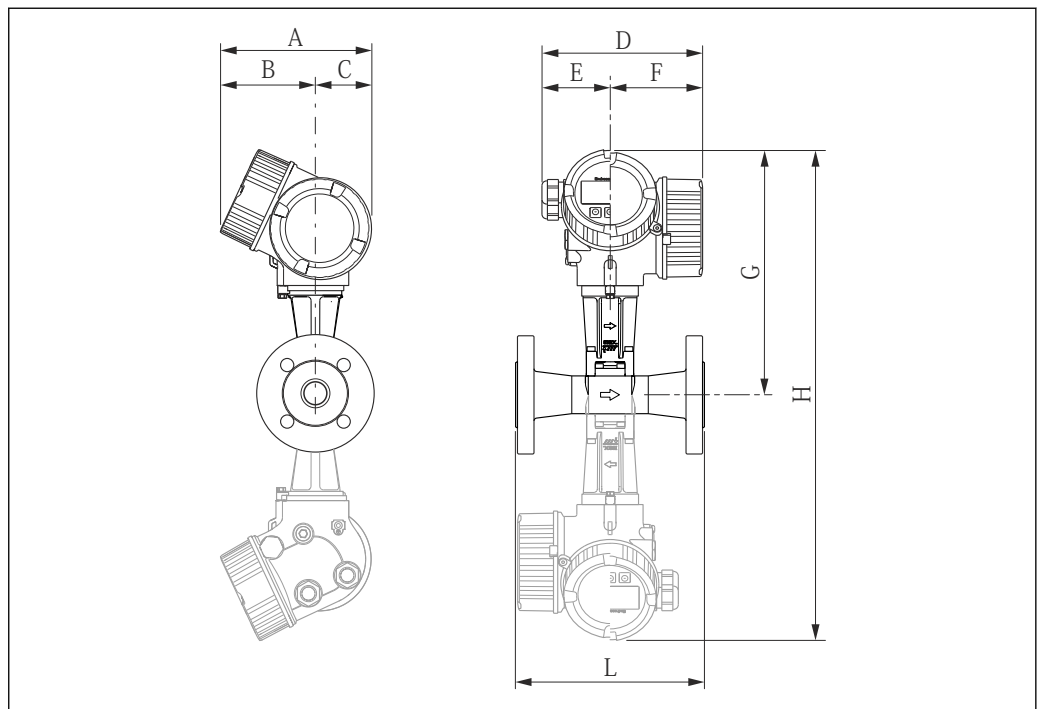

A0019267

23 Gray broken line: Dualsens version

Dimensions in SI units

DN	A	B ¹⁾	C	D ²⁾	E	F ²⁾	G ^{3) 4)}	H ^{5) 6)}	L
[mm]	[mm]	[mm]	[mm]	[mm]	[mm]	[mm]	[mm]	[mm]	[mm]
15	162	102	60	165	75	90	254.0	⁷⁾	⁸⁾
25	162	102	60	165	75	90	260.4	⁷⁾	⁸⁾
40	162	102	60	165	75	90	268.5	537.0	⁸⁾
50	162	102	60	165	75	90	275.3	550.6	⁸⁾
80	162	102	60	165	75	90	288.2	576.4	⁸⁾
100	162	102	60	165	75	90	300.1	600.2	⁸⁾
150	162	102	60	165	75	90	324.8	649.6	⁸⁾
200	162	102	60	165	75	90	353.4	706.8	⁸⁾
250	162	102	60	165	75	90	379.3	758.6	⁸⁾
300	162	102	60	165	75	90	404.4	808.8	⁸⁾

- 1) For version without local display: values - 7 mm
- 2) For version with overvoltage protection: values + 8 mm
- 3) For version without local display: values - 10 mm
- 4) For high-temperature/low-temperature version: values + 29 mm
- 5) For version without local display: values - 20 mm
- 6) For high-temperature/low-temperature version: values + 58 mm
- 7) Not available as a Dualsens version
- 8) dependent on respective process connection

Dimensions in US units

DN	A	B ¹⁾	C	D ²⁾	E	F ²⁾	G ^{3) 4)}	H ^{5) 6)}	L
[in]	[in]	[in]	[in]	[in]	[in]	[in]	[in]	[in]	[in]
½	6.38	4.02	2.36	6.50	2.95	3.54	10.00	⁷⁾	⁸⁾
1	6.38	4.02	2.36	6.50	2.95	3.54	10.25	⁷⁾	⁸⁾
1½	6.38	4.02	2.36	6.50	2.95	3.54	10.57	21.14	⁸⁾
2	6.38	4.02	2.36	6.50	2.95	3.54	10.84	21.68	⁸⁾
3	6.38	4.02	2.36	6.50	2.95	3.54	11.35	22.69	⁸⁾
4	6.38	4.02	2.36	6.50	2.95	3.54	11.81	23.63	⁸⁾
6	6.38	4.02	2.36	6.50	2.95	3.54	12.79	25.57	⁸⁾
8	6.38	4.02	2.36	6.50	2.95	3.54	13.91	27.63	⁸⁾
10	6.38	4.02	2.36	6.50	2.95	3.54	14.93	29.67	⁸⁾
12	6.38	4.02	2.36	6.50	2.95	3.54	15.92	31.84	⁸⁾

- 1) For version without local display: values - 0.28 in
- 2) For version with overvoltage protection: values + 0.31 in
- 3) For version without local display: values - 0.39 in
- 4) For high-temperature/low-temperature version: values + 1.14 in
- 5) For version without local display: values - 0.78 in
- 6) For high-temperature/low-temperature version: values + 2.28 in
- 7) Not available as a Dualsens version
- 8) dependent on respective process connection

Transmitter remote version

Order code for "Housing", option J "GT20, remote, aluminum coated"; option K "GT18 remote, 316L"

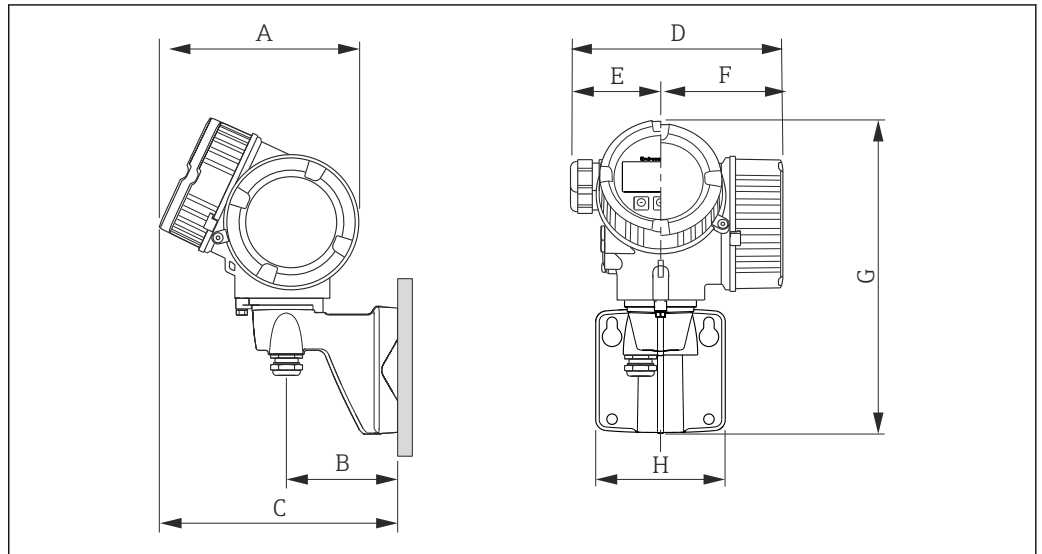

A0020089

Dimensions in SI units

A ¹⁾ [mm]	B [mm]	C ¹⁾ [mm]	D ²⁾ [mm]	E [mm]	F ²⁾ [mm]	G ³⁾ [mm]	H [mm]
162	90	191	165	75	90	254	107

- 1) For device version without local display: value - 7 mm
- 2) For device version with overvoltage protection (OVP): value + 8 mm
- 3) For device version without local operation: value - 10 mm

Dimensions in US units

A ¹⁾ [in]	B [in]	C [in]	D ²⁾ [in]	E [in]	F [in]	G ³⁾ [in]	H [in]
6.38	3.54	7.52	6.5	2.75	3.54	10.0	4.21

- 1) For device version without local display: value - 0.28 in
- 2) For device version with overvoltage protection (OVP): value + 0.31 in
- 3) For device version without local operation: value - 0.39 in

Sensor remote version

Order code for "Housing", option J "GT20, remote, aluminum coated"; option K "GT18, remote, 316L"

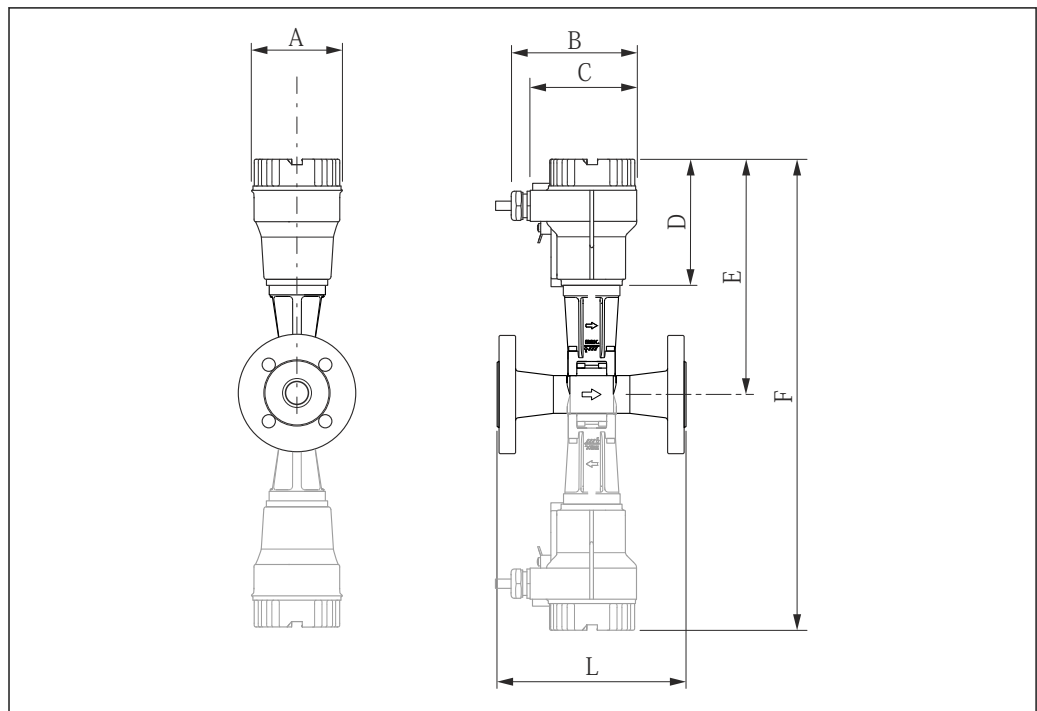

A0019336

24 Gray broken line: Dualsens version

Dimensions in SI units

DN [mm]	A [mm]	B [mm]	C [mm]	D [mm]	E ¹⁾ [mm]	F ²⁾ [mm]	L [mm]
15	94.3	134.3	107.3	115.8	224.3	³⁾	⁴⁾
25	94.3	134.3	107.3	115.8	230.7	³⁾	⁴⁾
40	94.3	134.3	107.3	115.8	238.8	477.6	⁴⁾
50	94.3	134.3	107.3	115.8	245.6	491.2	⁴⁾
80	94.3	134.3	107.3	115.8	258.5	517.0	⁴⁾
100	94.3	134.3	107.3	115.8	270.4	540.8	⁴⁾
150	94.3	134.3	107.3	115.8	295.1	590.2	⁴⁾
200	94.3	134.3	107.3	115.8	323.7	647.4	⁴⁾
250	94.3	134.3	107.3	115.8	349.6	699.2	⁴⁾
300	94.3	134.3	107.3	115.8	374.7	749.4	⁴⁾

- 1) For high-temperature/low-temperature version: values + 29 mm
- 2) For high-temperature/low-temperature version: values + 58 mm
- 3) Not available as a Dualsens version
- 4) dependent on respective process connection

Dimensions in US units

DN [in]	A [in]	B [in]	C [in]	D [in]	E ¹⁾ [in]	F ²⁾ [in]	L [in]
½	3.71	5.29	4.22	4.56	8.83	3)	4)
1	3.71	5.29	4.22	4.56	9.08	3)	4)
1½	3.71	5.29	4.22	4.56	9.40	18.80	4)
2	3.71	5.29	4.22	4.56	9.67	19.34	4)
3	3.71	5.29	4.22	4.56	10.18	20.35	4)
4	3.71	5.29	4.22	4.56	10.65	21.29	4)
6	3.71	5.29	4.22	4.56	11.62	23.24	4)
8	3.71	5.29	4.22	4.56	12.74	25.49	4)
10	3.71	5.29	4.22	4.56	13.76	27.53	4)
12	3.71	5.29	4.22	4.56	14.75	29.50	4)

- 1) For high-temperature/low-temperature version: values + 1.14 in
- 2) For high-temperature/low-temperature version: values + 2.28 in
- 3) Not available as a Dualsens version
- 4) dependent on respective process connection

Process connections in SI units

Flange connections EN (DIN)

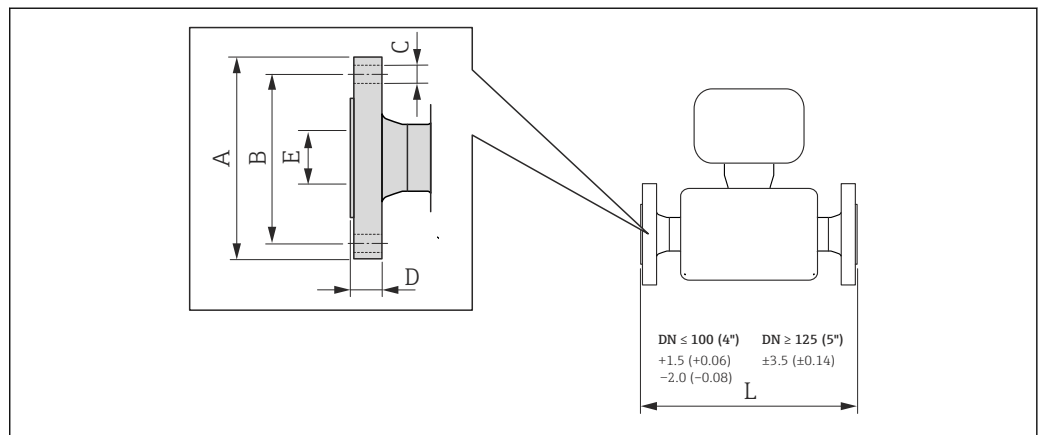

A0015621

25 Engineering unit mm (in)

Flange according to EN 1092-1 (DIN 2501), PN 10: 1.4408 (order code for "Process connection", option DDS)

Raised face according to: EN 1092-1 Form B1 (DIN 2526 Form C), Ra 6.3 to 12.5 µm

DN [mm]	A [mm]	B [mm]	∅ C [mm]	D [mm]	E [mm]	L ¹⁾ [mm]
200	340	295	8 × 22	42	207.3	300
250	395	350	12 × 22	48	260.4	380
300	445	400	12 × 22	51	309.7	450

- 1) Available in compliance with ISO 13359 on request: for DN 200 to 300 (350 mm for DN 200, 450 mm for DN 250, 500 mm for DN 300).

Flange according to EN 1092-1 (DIN 2501), PN 16: 1.4404/CX2MW ¹⁾ or 1.4408 ²⁾ (order code for "Process connection", option D1S)						
Raised face according to: EN 1092-1 Form B1 (DIN 2526 Form C), Ra 6.3 to 12.5 µm						
DN [mm]	A [mm]	B [mm]	∅ C [mm]	D [mm]	E [mm]	L ^{3) 4)} [mm]
100	220	180	8 × 18	20	107.1	250
150	285	240	8 × 22	22	159.3	300
200	340	295	12 × 22	42	207.3	300
250	405	355	12 × 26	48	260.4	380
300	460	410	12 × 26	51	309.7	450

- 1) DN 15 to 150
- 2) DN 200 to 300
- 3) In compliance with ISO 13359 for DN 15 to 150.
- 4) Available in compliance with ISO 13359 on request: for DN 200 to 300 (350 mm for DN 200, 450 mm for DN 250, 500 mm for DN 300).

Flange according to EN 1092-1 (DIN 2501), PN 16 with groove: 1.4404/CX2MW (order code for "Process connection", option D5S)						
Raised face according to: EN 1091-1 Form D (DIN 2512 Form N), Ra 6.3 to 12.5 µm						
DN [mm]	A [mm]	B [mm]	∅ C [mm]	D [mm]	E [mm]	L ¹⁾ [mm]
100	220	180	8 × 18	20	107.1	250
150	285	240	8 × 22	22	159.3	300

- 1) In compliance with ISO 13359 for DN 15 to 150.

Flange according to EN 1092-1 (DIN 2501), PN 25: 1.4408 (order code for "Process connection", option DES)						
Raised face according to: EN 1092-1 Form B1 (DIN 2526 Form C), Ra 6.3 to 12.5 µm						
DN [mm]	A [mm]	B [mm]	∅ C [mm]	D [mm]	E [mm]	L ¹⁾ [mm]
200	360	310.0	12 × 26	42	206.5	300
250	425	370	12 × 30	48	258.8	380
300	485	430	16 × 30	51	307.9	450

- 1) Available in compliance with ISO 13359 on request: for DN 200 to 300 (for DN 200: 350 mm; for DN 250: 450 mm; for DN 300: 500 mm).

Flange according to EN 1092-1 (DIN 2501), PN 40: 1.4404/CX2MW ¹⁾ or 1.4408 ²⁾ (order code for "Process connection", option D2S)						
Raised face according to: EN 1092-1 Form B1 (DIN 2526 Form C), Ra 6.3 to 12.5 µm						
DN [mm]	A [mm]	B [mm]	∅ C [mm]	D [mm]	E [mm]	L ^{3) 4)} [mm]
15 ⁵⁾	95	65	4 × 14	16	17.3	200
25 ⁵⁾	115	85	4 × 14	18	28.5	200
40	150	110	4 × 18	18	43.1	200
50	165	125	4 × 18	20	54.4	200
80	200	160	8 × 18	24	82.5	200
100	235	190	8 × 22	24	107.1	250

Flange according to EN 1092-1 (DIN 2501), PN 40: 1.4404/CX2MW¹⁾ or 1.4408²⁾ (order code for "Process connection", option D2S)

Raised face according to: EN 1092-1 Form B1 (DIN 2526 Form C), Ra 6.3 to 12.5 µm

DN [mm]	A [mm]	B [mm]	∅ C [mm]	D [mm]	E [mm]	L ^{3) 4)} [mm]
150	300	250	8 × 26	28	159.3	300
200	375	320.0	12 × 30	42	206.5	300
250	450	385	12 × 33	48	258.8	380
300	515	450	16 × 33	51	307.9	450

- 1) DN 15 to 150
- 2) DN 200 to 300
- 3) In compliance with ISO 13359 for DN 15 to 150.
- 4) Available in compliance with ISO 13359 on request: for DN 200 to 300 (350 mm for DN 200, 450 mm for DN 250, 500 mm for DN 300).
- 5) Not available as a Dualsens version

Flange according to EN 1092-1 (DIN 2501), PN 40 with groove: 1.4404/CX2MW (order code for "Process connection", option D6S)

Raised face according to: EN 1091-1 Form D (DIN 2512 Form N), Ra 6.3 to 12.5 µm

DN [mm]	A [mm]	B [mm]	∅ C [mm]	D [mm]	E [mm]	L ^{1) 2)} [mm]
15 ³⁾	95	65	4 × 14	16	17.3	200
25 ³⁾	115	85	4 × 14	18	28.5	200
40	150	110	4 × 18	18	43.1	200
50	165	125	4 × 18	20	54.4	200
80	200	160	8 × 18	24	82.5	200
100	235	190	8 × 22	24	107.1	250
150	300	250	8 × 26	28	159.3	300

- 1) In compliance with ISO 13359 for DN 15 to 150.
- 2) Available in compliance with ISO 13359 on request: for DN 200 to 300 (350 mm for DN 200, 450 mm for DN 250, 500 mm for DN 300).
- 3) Not available as a Dualsens version

Flange connections ASME B16.5

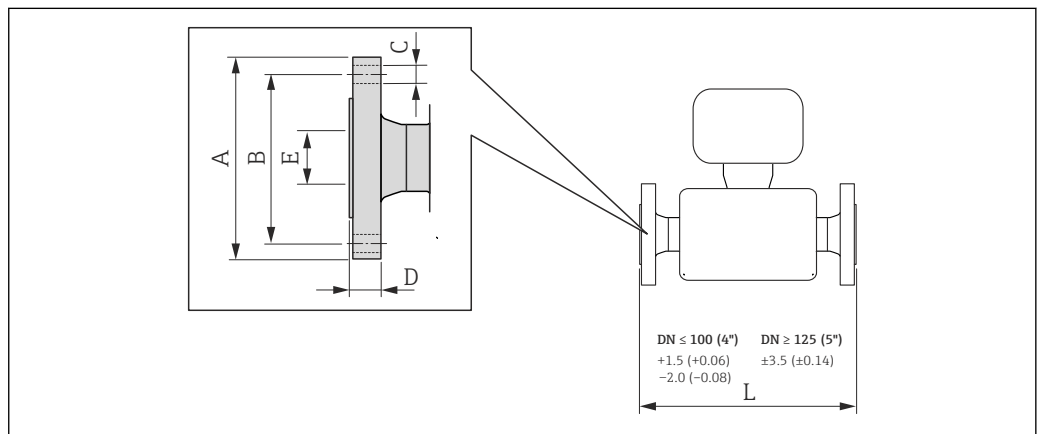

26 Engineering unit mm (in)

A0015621

Flange according to ASME B16.5, Cl. 150/Sch. 40: 1.4404/CX2MW ¹⁾ or 1.4408 ²⁾ (order code for "Process connection", option AAS)						
Surface roughness (flange): Ra 3.2 to 6.3 µm						
DN [mm]	A [mm]	B [mm]	∅ C [mm]	D [mm]	E [mm]	L [mm]
15 ³⁾	88.9	60.5	4 × 15.7	11.2	15.7	200
25 ³⁾	107.9	79.2	4 × 15.7	15.7	26.7	200
40	127.0	98.6	4 × 15.7	17.5	40.9	200
50	152.4	120.7	4 × 19.1	19.1	52.6	200
80	190.5	152.4	4 × 19.1	23.9	78.0	200
100	228.6	190.5	8 × 19.1	24.5	102.4	250
150	279.4	241.3	8 × 22.4	25.4	154.2	300
200	342.9	298.5	8 × 22.4	42.0	202.7	300
250	406.4	362.0	12 × 25.4	48.0	254.5	380
300	482.6	431.8	12 × 25.4	60.0	304.8	450

- 1) DN 15 to 150
 2) DN 200 to 300
 3) Not available as a Dualsens version

Flange according to ASME B16.5, Cl. 150/Sch. 80: 1.4404/CX2MW (order code for "Process connection", option AFS)						
Surface roughness (flange): Ra 3.2 to 6.3 µm						
DN [mm]	A [mm]	B [mm]	∅ C [mm]	D [mm]	E [mm]	L [mm]
15 ¹⁾	88.9	60.5	4 × 15.7	11.2	13.9	200
25	107.9	79.2	4 × 15.7	15.7	24.3	200
40	127.0	98.6	4 × 15.7	17.5	38.1	200
50	152.4	120.7	4 × 19.1	19.1	49.2	200
80	190.5	152.4	4 × 19.1	23.9	73.7	200
100	228.6	190.5	8 × 19.1	24.5	97.0	250
150	279.4	241.3	8 × 22.4	25.4	146.3	300

- 1) Not available as a Dualsens version

Flange according to ASME B16.5, Cl. 300/Sch. 40: 1.4404/CX2MW ¹⁾ or 1.4408 ²⁾ (order code for "Process connection", option ABS)						
Surface roughness (flange): Ra 3.2 to 6.3 µm						
DN [mm]	A [mm]	B [mm]	∅ C [mm]	D [mm]	E [mm]	L [mm]
15 ³⁾	95.0	66.5	4 × 15.7	14.2	15.7	200
25 ³⁾	123.8	88.9	4 × 19.1	19.1	26.7	200
40	155.6	114.3	4 × 22.4	20.6	40.9	200
50	165.0	127.0	8 × 19.1	22.4	52.6	200
80	210.0	168.1	8 × 22.4	28.4	78.0	200
100	254.0	200.2	8 × 22.4	31.8	102.4	250
150	317.5	269.7	12 × 22.4	36.6	152.2	300
200	381.0	330.2	12 × 25.4	42.0	202.7	300

Flange according to ASME B16.5, Cl. 300/Sch. 40: 1.4404/CX2MW¹⁾ or 1.4408²⁾ (order code for "Process connection", option ABS)

Surface roughness (flange): Ra 3.2 to 6.3 µm

DN [mm]	A [mm]	B [mm]	∅ C [mm]	D [mm]	E [mm]	L [mm]
250	444.5	387.4	16 × 28.4	48.0	254.5	380
300	520.7	450.9	16 × 31.8	60.0	304.8	450

- 1) DN 15 to 150
- 2) DN 200 to 300
- 3) Not available as a Dualsens version

Flange according to ASME B16.5, Cl. 300/Sch. 80: 1.4404/CX2MW (order code for "Process connection", option AGS)

Surface roughness (flange): Ra 3.2 to 6.3 µm

DN [mm]	A [mm]	B [mm]	∅ C [mm]	D [mm]	E [mm]	L [mm]
15 ¹⁾	95.0	66.5	4 × 15.7	14.2	13.9	200
25 ¹⁾	123.8	88.9	4 × 19.1	19.1	24.3	200
40	155.6	114.3	4 × 22.4	20.6	38.1	200
50	165.0	127.0	8 × 19.1	22.4	49.2	200
80	210.0	168.1	8 × 22.4	28.4	73.7	200
100	254.0	200.2	8 × 22.4	31.8	97.0	250
150	317.5	269.7	12 × 22.4	36.6	146.3	300

- 1) Not available as a Dualsens version

Flange connections JIS

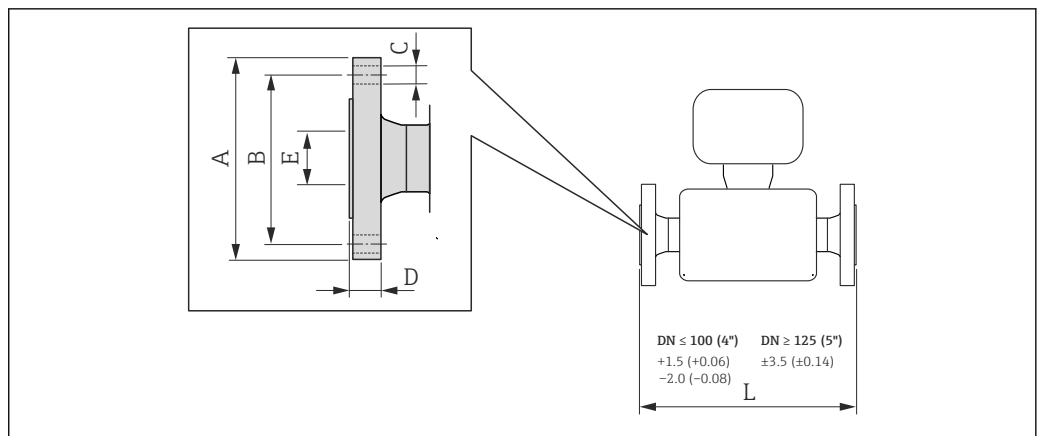

27 Engineering unit mm (in)

Flange according to JIS B2220, 10K/Sch. 40: 1.4404/CX2MW¹⁾ or 1.4408²⁾ (order code for "Process connection", option NDS)

Surface roughness (flange): Ra 3.2 to 6.3 µm

DN [mm]	A [mm]	B [mm]	∅ C [mm]	D [mm]	E [mm]	L [mm]
50	155	120	4 × 19	16	52.7	200
80	185	150	8 × 19	18	78.1	200

Flange according to JIS B2220, 10K/Sch. 40: 1.4404/CX2MW ¹⁾ or 1.4408 ²⁾ (order code for "Process connection", option NDS)						
Surface roughness (flange): Ra 3.2 to 6.3 µm						
DN [mm]	A [mm]	B [mm]	∅ C [mm]	D [mm]	E [mm]	L [mm]
100	210	195	8 × 19	18	102.3	250
150	280	240	8 × 23	22	151.0	300
200	330	290	12 × 23	42	202.7	300
250	400	355	12 × 25	48	254.5	380
300	445	400	16 × 25	51	304.8	450

1) DN 15 to 150

2) DN 200 to 300

Flange according to JIS B2220, 10K/Sch. 80: 1.4404/CX2MW (order code for "Process connection", option NFS)						
Surface roughness (flange): Ra 3.2 to 6.3 µm						
DN [mm]	A [mm]	B [mm]	∅ C [mm]	D [mm]	E [mm]	L [mm]
50	155	120	4 × 19	16	49.2	200
80	185	150	8 × 19	18	73.7	200
100	210	195	8 × 19	18	97.0	250
150	280	240	8 × 23	22	146.3	300

Flange according to JIS B2220, 20K/Sch. 40: 1.4404/CX2MW ¹⁾ or 1.4408 ²⁾ (order code for "Process connection", option NES)						
Surface roughness (flange): Ra 3.2 to 6.3 µm						
DN [mm]	A [mm]	B [mm]	∅ C [mm]	D [mm]	E [mm]	L [mm]
15 ³⁾	95	70	4 × 15	14	16.1	200
25 ³⁾	125	90	4 × 19	16	27.2	200
40	140	105	4 × 19	18	41.2	200
50	155	120	8 × 19	18	52.7	200
80	200	160	8 × 23	22	78.1	200
100	225	185	8 × 23	24	102.3	250
150	305	260	12 × 25	28	151.0	300
200	350	305	12 × 25	42	202.7	300
250	430	380	12 × 27	48	254.5	380
300	480	430	16 × 27	51	304.8	450

1) DN 15 to 150

2) DN 200 to 300

3) Not available as a Dualsens version

Flange according to JIS B2220, 20K/Sch. 80: 1.4404/CX2MW (order code for "Process connection", option NGS)

Surface roughness (flange): Ra 3.2 to 6.3 µm

DN [mm]	A [mm]	B [mm]	∅ C [mm]	D [mm]	E [mm]	L [mm]
15 ¹⁾	95	70	4 × 15	14	13.9	200
25 ¹⁾	125	90	4 × 19	16	24.3	200
40	140	105	4 × 19	18	38.1	200
50	155	120	8 × 19	18	49.2	200
80	200	160	8 × 23	22	73.7	200
100	225	185	8 × 23	24	97.0	250
150	305	260	12 × 25	28	146.8	300

1) Not available as a Dualsens version

Process connections in US units

Flange connections ASME B16.5

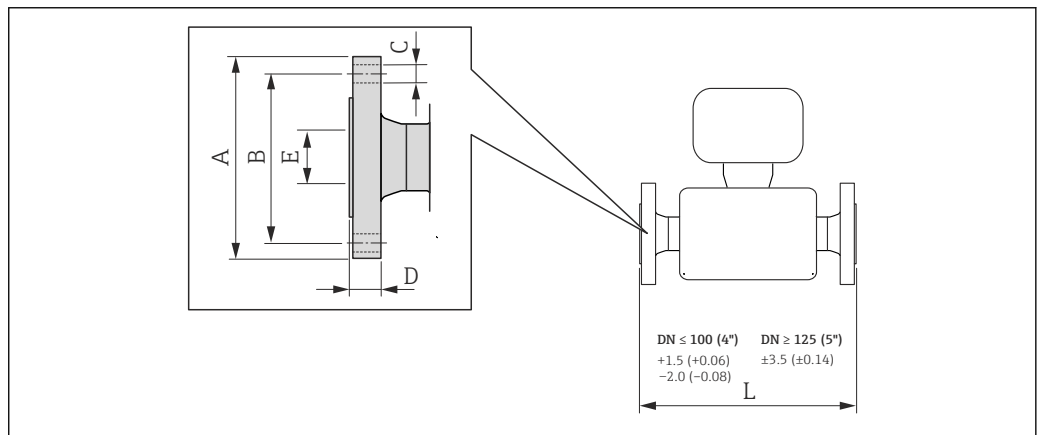

A0015621

28 Engineering unit mm (in)

Flange according to ASME B16.5, Cl. 150/Sch. 40: F316, F316L/CX2MW¹⁾ or CF3M²⁾ (order code for "Process connection", option AAS)

Surface roughness (flange): Ra 125 to 250µin

DN [in]	A [in]	B [in]	∅ C [in]	D [in]	E [in]	L [in]
½ ³⁾	3.50	2.38	4 × 0.62	0.44	0.62	7.88
1 ³⁾	4.25	3.12	4 × 0.62	0.62	1.05	7.88
1½	5.00	3.88	4 × 0.62	0.69	1.61	7.88
2	6.00	4.75	4 × 0.75	0.75	2.07	7.88
3	7.51	6.00	4 × 0.75	0.94	3.07	7.88
4	9.01	7.50	8 × 0.75	0.97	4.03	9.85
6	11.01	9.50	8 × 0.88	1.00	6.08	11.82
8	13.51	11.80	8 × 0.88	1.65	7.99	11.82

Flange according to ASME B16.5, Cl. 150/Sch. 40: F316, F316L/CX2MW ¹⁾ or CF3M ²⁾ (order code for "Process connection", option AAS)						
Surface roughness (flange): Ra 125 to 250µin						
DN [in]	A [in]	B [in]	∅ C [in]	D [in]	E [in]	L [in]
10	16.01	14.30	12 × 1	1.89	10.03	14.79
12	19.01	17.00	12 × 1	2.36	12.01	17.73

- 1) DN ½ to 6"
- 2) DN 8 to 12"
- 3) Not available as a Dualsens version

Flange according to ASME B16.5, Cl. 150/Sch. 80: F316, F316L/CX2MW (order code for "Process connection", option AFS)						
Surface roughness (flange): Ra 125 to 250µin						
DN [in]	A [in]	B [in]	∅ C [in]	D [in]	E [in]	L [in]
½ ¹⁾	3.50	2.38	4 × 0.62	0.44	0.55	7.88
1 ¹⁾	4.25	3.12	4 × 0.62	0.62	0.96	7.88
1½	5.00	3.88	4 × 0.62	0.69	1.50	7.88
2	6.00	4.75	4 × 0.75	0.75	1.94	7.88
3	7.51	6	4 × 0.75	0.94	2.90	7.88
4	9.01	7.5	8 × 0.75	0.97	3.82	9.85
6	11.01	9.5	8 × 0.88	1.00	5.76	11.82

- 1) Not available as a Dualsens version

Flange according to ASME B16.5, Cl. 300/Sch. 40: F316, F316L/CX2MW ¹⁾ or CF3M ²⁾ (order code for "Process connection", option ABS)						
Surface roughness (flange): Ra 125 to 250µin						
DN [in]	A [in]	B [in]	∅ C [in]	D [in]	E [in]	L [in]
½ ³⁾	3.74	2.62	4 × 0.62	0.56	0.62	7.88
1 ³⁾	4.88	3.5	4 × 0.75	0.75	1.05	7.88
1½	6.13	4.5	4 × 0.88	0.81	1.61	7.88
2	6.50	5	8 × 0.75	0.88	2.07	7.88
3	8.27	6.62	8 × 0.88	1.12	3.07	7.88
4	10.01	7.88	8 × 0.88	1.25	4.03	9.85
6	12.51	10.6	12 × 0.88	1.44	6.08	11.82
8	15.01	13	12 × 1	1.65	7.99	11.82
10	17.51	15.3	16 × 1.12	1.89	10.03	14.79
12	20.52	17.8	16 × 1.25	2.36	12.01	17.73

- 1) DN ½ to 6"
- 2) DN 8 to 12"
- 3) Not available as a Dualsens version

Flange according to ASME B16.5, Cl. 300/Sch. 80: F316, F316L/CX2MW (order code for "Process connection", option AGS)

Surface roughness (flange): Ra 125 to 250µin

DN [in]	A [in]	B [in]	∅ C [in]	D [in]	E [in]	L [in]
½ ¹⁾	3.74	2.62	4 × 0.62	0.56	0.55	7.88
1 ¹⁾	4.88	3.5	4 × 0.75	0.75	0.96	7.88
1½	6.13	4.5	4 × 0.88	0.81	1.50	7.88
2	6.50	5	8 × 0.75	0.88	1.94	7.88
3	8.27	6.62	8 × 0.88	1.12	2.90	7.88
4	10.01	7.88	8 × 0.88	1.25	3.82	9.85
6	12.51	10.6	12 × 0.88	1.44	5.76	11.82

1) Not available as a Dualsens version

Accessories

Flow conditioner

Order code for "Accessory enclosed", option PF "Flow conditioner"

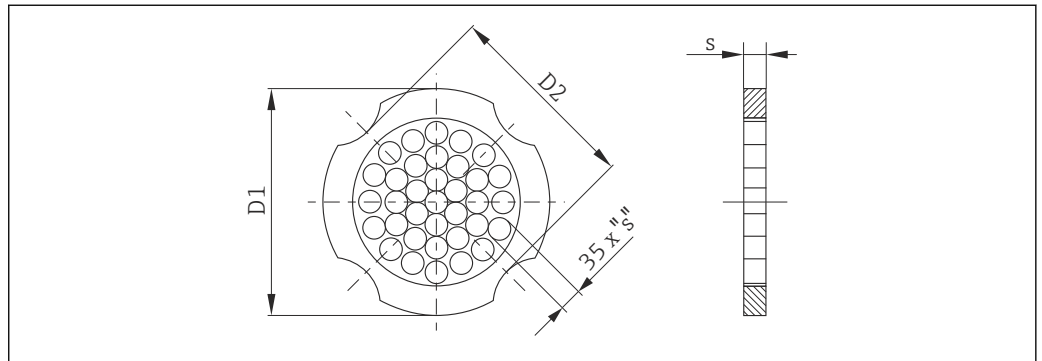

A0001941

Dimensions in SI units

DN ¹⁾ [mm]	Pressure rating	Centering diameter [mm]	D1 ²⁾ / D2 ³⁾	s [mm]
15	PN10 to 40	54.3	D2	2.0
25	PN10 to 40	74.3	D1	3.5
40	PN10 to 40	95.3	D1	5.3
50	PN10 to 40	110.0	D2	6.8
80	PN10 to 40	145.3	D2	10.1
100	PN 10/16 PN 25/40	165.3 171.3	D2 D1	13.3
150	PN 10/16 PN 25/40	221.0 227.0	D2 D2	20.0
200	PN 10 PN 16 PN 25 PN 40	274.0 274.0 280.0 294.0	D1 D2 D1 D2	26.3

DN ¹⁾ [mm]	Pressure rating	Centering diameter [mm]	D1 ²⁾ / D2 ³⁾	s [mm]
250	PN 10/16	330.0	D2	33.0
	PN 25	340.0	D1	
	PN 40	355.0	D2	
300	PN 10/16	380.0	D2	39.6
	PN 25	404.0	D1	
	PN 40	420.0	D1	

- 1) EN (DIN)
- 2) The flow conditioner is fitted at the outer diameter between the bolts.
- 3) The flow conditioner is fitted at the indentations between the bolts.

DN ¹⁾ [mm]	Pressure rating	Centering diameter [mm]	D1 ²⁾ / D2 ³⁾	s [mm]
15	Class 150	50.1	D1	2.0
	Class 300	56.5	D1	
25	Class 150	69.2	D2	3.5
	Class 300	74.3	D1	
40	Class 150	88.2	D2	5.3
	Class 300	97.7	D2	
50	Class 150	106.6	D2	6.8
	Class 300	113.0	D1	
80	Class 150	138.4	D1	10.1
	Class 300	151.3	D1	
100	Class 150	176.5	D2	13.3
	Class 300	182.6	D1	
150	Class 150	223.5	D1	20.0
	Class 300	252.0	D1	
200	Class 150	274.0	D2	26.3
	Class 300	309.0	D1	
250	Class 150	340.0	D1	33.0
	Class 300	363.0	D1	
300	Class 150	404.0	D1	39.6
	Class 300	402.0	D1	

- 1) ASME
- 2) The flow conditioner is fitted at the outer diameter between the bolts.
- 3) The flow conditioner is fitted at the indentations between the bolts.

DN ¹⁾ [mm]	Pressure rating	Centering diameter [mm]	D1 ²⁾ / D2 ³⁾	s [mm]
15	10 K	60.3	D2	2.0
	20 K	60.3	D2	
25	10 K	76.3	D2	3.5
	20 K	76.3	D2	
40	10 K	91.3	D2	5.3
	20 K	91.3	D2	
50	10 K	106.6	D2	6.8
	20 K	106.6	D2	
80	10 K	136.3	D2	10.1
	20 K	142.3	D1	
100	10 K	161.3	D2	13.3
	20 K	167.3	D1	

DN ¹⁾ [mm]	Pressure rating	Centering diameter [mm]	D1 ²⁾ / D2 ³⁾	s [mm]
150	10 K	221.0	D2	20.0
	20 K	240.0	D1	
200	10 K	271.0	D2	26.3
	20 K	284.0	D1	
250	10 K	330.0	D2	33.0
	20 K	355.0	D2	
300	10 K	380.0	D2	39.6
	20 K	404.0	D1	

- 1) JIS
- 2) The flow conditioner is fitted at the outer diameter between the bolts.
- 3) The flow conditioner is fitted at the indentations between the bolts.

Dimensions in US units

DN [in]	Pressure rating	Centering diameter [in]	D1 ¹⁾ / D2 ²⁾	s [in]
½	Class 150	1.97	D1	0.08
	Class 300	2.22	D1	
1	Class 150	2.72	D2	0.14
	Class 300	2.93	D1	
1½	Class 150	3.47	D2	0.21
	Class 300	3.85	D2	
2	Class 150	4.09	D2	0.27
	Class 300	4.45	D1	
3	Class 150	5.45	D1	0.40
	Class 300	5.96	D1	
4	Class 150	6.95	D2	0.52
	Class 300	7.19	D1	
6	Class 150	8.81	D1	0.79
	Class 300	9.92	D1	
8	Class 150	10.80	D2	1.04
	Class 300	12.20	D1	
10	Class 150	13.40	D1	1.30
	Class 300	14.30	D1	
12	Class 150	15.90	D1	1.56
	Class 300	15.80	D1	

- 1) The flow conditioner is fitted at the outer diameter between the bolts.
- 2) The flow conditioner is fitted at the indentations between the bolts.

Weight

Compact version

Weight data:

- Including the transmitter:
 - Order code for "Housing", option C: 1.8 kg (4.0 lb)
 - Order code for "Housing", option B: 4.5 kg (9.9 lb)
- Excluding packaging material

Weight in SI units

All values (weight) refer to devices with EN (DIN), PN 40 flanges. Weight information in [kg].

DN [mm]	Weight [kg]	
	Order code for "Housing", option C Aluminum, AlSi10Mg, coated ¹⁾	Order code for "Housing", option B Stainless steel, 1.4404 (316L) ¹⁾
15	5.1	7.8
25	7.1	9.8
40	9.1	11.8
50	11.1	13.8
80	16.1	18.8
100	21.1	23.8
150	37.1	39.8
200	72.1	74.8
250	111.1	113.8
300	158.1	160.8

1) For high-temperature/low-temperature version: values + 0.2 kg

Weight in US units

All values (weight) refer to devices with ASME B16.5, Class 300/Sch. 40 flanges. Weight information in [lbs].

DN [in]	Weight [lbs]	
	Order code for "Housing", option C Aluminum, AlSi10Mg, coated ¹⁾	Order code for "Housing", option B Stainless steel, 1.4404 (316L) ¹⁾
½	11.3	17.3
1	15.7	21.7
1½	22.4	28.3
2	26.8	32.7
3	42.2	48.1
4	66.5	72.4
6	110.5	116.5
8	167.9	173.8
10	240.6	246.6
12	357.5	363.4

1) For high-temperature/low-temperature version: values + 0.4 lbs

Transmitter remote version*Wall-mount housing*

Depends on the material of the wall-mount housing:

- Aluminum, AlSi10Mg, coated: 2.4 kg (5.2 lb)
- Stainless steel, 1.4404 (316L): 6.0 kg (13.2 lb)

Sensor remote version

Weight data:

- Including the connection housing:
 - Aluminum, AlSi10Mg, coated: 0.8 kg (1.8 lb)
 - Stainless cast steel, 1.4408 (CF3M): 2.0 kg (4.4 lb)
- Excluding the connecting cable
- Excluding packaging material

Weight in SI units

All values (weight) refer to devices with EN (DIN), PN 40 flanges. Weight information in [kg].

DN [mm]	Weight [kg]	
	Connection housing Aluminum, AlSi10Mg, coated ¹⁾	Connection housing Stainless cast steel, 1.4408 (CF3M) ¹⁾
15	4.1	5.3
25	6.1	7.3
40	8.1	9.3
50	10.1	11.3
80	15.1	16.3
100	20.1	21.3
150	36.1	37.3
200	71.1	72.3
250	110.1	111.3
300	157.1	158.3

1) For high-temperature/low-temperature version: values + 0.2 kg

Weight in US units

All values (weight) refer to devices with ASME B16.5, Class 300/Sch. 40 flanges. Weight information in [lbs].

DN [in]	Weight [lbs]	
	Connection housing Aluminum, AlSi10Mg, coated ¹⁾	Connection housing Stainless cast steel, 1.4408 (CF3M) ¹⁾
½	8.9	11.7
1	13.4	16.1
1½	20.0	22.7
2	24.4	27.2
3	39.8	42.6
4	64.1	66.8
6	108.2	110.9
8	165.5	168.3
10	238.2	241.0
12	355.1	357.8

1) For high-temperature/low-temperature version: values + 0.4 lbs

Accessories*Flow conditioner**Weight in SI units*

DN ¹⁾ [mm]	Pressure rating	Weight [kg]
15	PN 10 to 40	0.04
25	PN 10 to 40	0.1
40	PN 10 to 40	0.3
50	PN 10 to 40	0.5
80	PN 10 to 40	1.4
100	PN 10 to 40	2.4
150	PN 10/16 PN 25/40	6.3 7.8
200	PN 10 PN 16/25 PN 40	11.5 12.3 15.9
250	PN 10 to 25 PN 40	25.7 27.5
300	PN 10 to 25 PN 40	36.4 44.7

1) EN (DIN)

DN ¹⁾ [mm]	Pressure rating	Weight [kg]
15	Class 150 Class 300	0.03 0.04
25	Class 150 Class 300	0.1
40	Class 150 Class 300	0.3
50	Class 150 Class 300	0.5
80	Class 150 Class 300	1.2 1.4
100	Class 150 Class 300	2.7
150	Class 150 Class 300	6.3 7.8
200	Class 150 Class 300	12.3 15.8
250	Class 150 Class 300	25.7 27.5
300	Class 150 Class 300	36.4 44.6

1) ASME

DN ¹⁾ [mm]	Pressure rating	Weight [kg]
15	20K	0.06
25	20K	0.1
40	20K	0.3
50	10K 20K	0.5
80	10K 20K	1.1
100	10K 20K	1.80
150	10K 20K	4.5 5.5
200	10K 20K	9.2
250	10K 20K	15.8 19.1
300	10K 20K	26.5

1) JIS

Weight in US units

DN ¹⁾ [in]	Pressure rating	Weight [lbs]
½	Class 150 Class 300	0.07 0.09
1	Class 150 Class 300	0.3
1½	Class 150 Class 300	0.7
2	Class 150 Class 300	1.1
3	Class 150 Class 300	2.6 3.1
4	Class 150 Class 300	6.0
6	Class 150 Class 300	14.0 16.0
8	Class 150 Class 300	27.0 35.0
10	Class 150 Class 300	57.0 61.0
12	Class 150 Class 300	80.0 98.0

1) ASME

Materials

Transmitter housing

Compact version

- Order code for "Housing", option **C** "Compact, aluminum coated":
Aluminum, AlSi10Mg, coated
- Order code for "Housing", option **B** "Compact, stainless":
For maximum corrosion resistance: stainless steel 1.4404 (316L)

Remote version

- Order code for "Housing", option J "Remote, aluminum coated":
Aluminum, AlSi10Mg, coated
- Order code for "Housing", option K "Remote, stainless":
For maximum corrosion resistance: stainless steel 1.4404 (316L)

Cable entries/cable glands

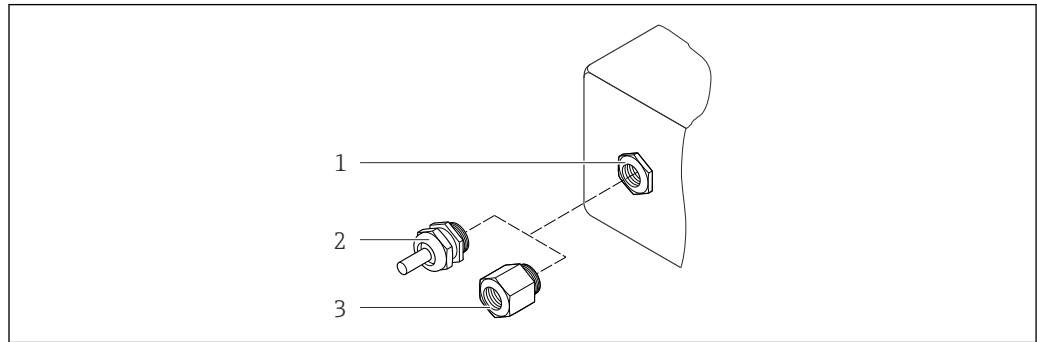

29 Possible cable entries/cable glands

- 1 Cable entry in transmitter housing, wall-mount housing or connection housing with internal thread M20 x 1.5
- 2 Cable gland M20 x 1.5
- 3 Adapter for cable entry with internal thread G 1/2" or NPT 1/2"

Order code for "Housing", option B "Compact, stainless", option K "Remote, stainless"

Cable entry/cable gland	Type of protection	Material
Cable gland M20 × 1.5	<ul style="list-style-type: none"> ■ Non-Ex ■ Ex ia ■ Ex ic ■ Ex nA ■ Ex tb 	Stainless steel ,1.4404
Adapter for cable entry with internal thread G 1/2"	For non-Ex and Ex (except for CSA Ex d/XP)	Stainless steel, 1.4404 (316L)
Adapter for cable entry with internal thread NPT 1/2"	For non-Ex and Ex	

Order code for "Housing": option C "Compact, aluminum coated", option J "Remote, aluminum coated"

Cable entry/cable gland	Type of protection	Material
Cable gland M20 × 1.5	<ul style="list-style-type: none"> ■ Non-Ex ■ Ex ia ■ Ex ic 	Plastic
	Adapter for cable entry with internal thread G 1/2"	Nickel-plated brass
Adapter for cable entry with internal thread NPT 1/2"	For non-Ex and Ex (except for CSA Ex d/XP)	Nickel-plated brass
Thread NPT 1/2" via adapter	For non-Ex and Ex	

Connecting cable for remote version

- Standard cable: PVC cable with copper shield
- Reinforced cable: PVC cable with copper shield and additional steel wire braided jacket

Sensor connection housing

- Coated aluminum AlSi10Mg
- Stainless cast steel, 1.4408 (CF3M), in compliance with NACE MR0175-2003 and MR0103-2003

Measuring tubes

Pressure ratings up to PN 40, Class 150/300, and JIS 10K/20K:

- Stainless cast steel, 1.4408 (CF3M), in compliance with AD2000 (for AD2000 the temperature range is limited to -10 to +400 °C (+14 to +752 °F)) and in compliance with NACE MR0175-2003 and MR0103-2003
- Cast alloy CX2MW similar to Alloy C22/2.4602, in compliance with NACE MR0175-2003 and MR0103-2003

DSC sensor

Pressure ratings up to PN 40, Class 150/300, and JIS 10K/20K:

Parts in contact with medium (marked as "wet" on the DSC sensor flange):

- Stainless steel, 1.4435 (316, 316L), in compliance with NACE MR0175-2003 and MR0103-2003
- Order code for "Sensor option", option CE "Harsh process, wetted parts, Alloy C22, (including option CD)":
UNS N06022 similar to Alloy C22/2.4602, in compliance with NACE MR0175-2003 and MR0103-2003

Parts not in contact with medium:

- Stainless steel 1.4301 (304)
- Order code for "Sensor option", option CD "Harsh environment, DSC sensor, sensor components Alloy C22":
Alloy C22 sensor: UNS N06022 similar to Alloy C22/2.4602, in compliance with NACE MR0175-2003 and MR0103-2003

Process connections

Pressure ratings up to PN 40, Class 150/300, and JIS 10K/20K:

Welding neck flanges DN 15 to 150 (½ to 6"), in compliance with NACE MR0175-2003 and MR0103-2003

The following materials are available depending on the pressure rating:

- Stainless steel, multiple certifications, 1.4404 (F316, F316L)
- Cast alloy CX2MW similar to Alloy C22/2.4602

DN 200 to 300 (8 to 12"):

Stainless cast steel, 1.4408 (CF3M)



List of all available process connections (→ 84)

Seals

- Graphite (standard)
Pressure rating PN 10 to 40, Class 150 to 300, JIS 10 to 20K: Sigraflex Foil Z (BAM-certified for oxygen applications)
- FPM (Viton)
- Kalrez 6375
- Gylon 3504 (BAM-certified for oxygen applications, "high quality in terms of TA Luft (German Clean Air Act)")

Housing support

Stainless steel, 1.4408 (CF3M)

Accessories

Weather protection cover

Stainless steel 1.4404 (316L)

Flow conditioner

Stainless steel, multiple certifications, 1.4404 (316, 316L), in compliance with NACE MR0175-2003 and MR0103-2003

Process connections

- EN 1092-1 (DIN 2501)
- ASME B16.5
- JIS B2220

 For information on the materials of the process connections (→  83)

Operability

Operating concept**Operator-oriented menu structure for user-specific tasks**

- Commissioning
- Operation
- Diagnostics
- Expert level

Quick and safe commissioning

- Guided menus ("Make-it-run" wizards) for applications
- Menu guidance with brief explanations of the individual parameter functions

Reliable operation

- Operation in the following languages:
 - Via local display: English, German, French, Spanish, Italian, Dutch, Portuguese, Polish, Russian, Swedish, Turkish, Chinese, Japanese, Korean, Bahasa (Indonesian), Vietnamese, Czech
 - Via "FieldCare" operating tool: English, German, French, Spanish, Italian, Chinese, Japanese
- Uniform operating philosophy applied to device and operating tools
- If replacing the electronic module, transfer the device configuration via the integrated memory (integrated HistoROM) which contains the process and measuring device data and the event logbook. No need to reconfigure.

Efficient diagnostics increase measurement availability

- Troubleshooting measures can be called up via the device and in the operating tools
- Diverse simulation options, logbook for events that occur and optional line recorder functions

Local operation**Via display module**

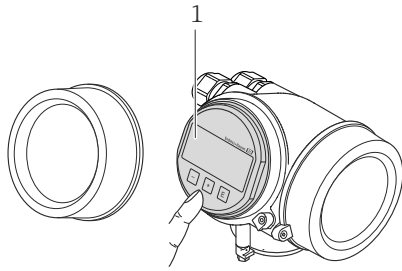
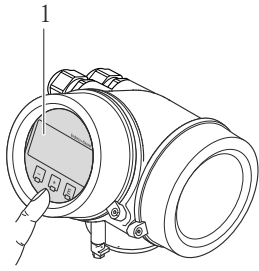
Order code for "Display; Operation", option C "SD02"	Order code for "Display; Operation", option E "SD03"
 <p style="text-align: right; font-size: small;">A0015544</p>	 <p style="text-align: right; font-size: small;">A0015546</p>
1 <i>Operation with pushbuttons</i>	1 <i>Operation with touch control</i>

Display elements

- 4-line display
- With order code for "Display; operation", option **E**:
 - White background lighting; switches to red in event of device errors
- Format for displaying measured variables and status variables can be individually configured
- Permitted ambient temperature for the display: -20 to $+60$ °C (-4 to $+140$ °F)
 - The readability of the display may be impaired at temperatures outside the temperature range.

Operating elements

- With order code for "Display; operation", option **C**:
Local operation with 3 push buttons: [⊖], [0], [⊕]
- With order code for "Display; operation", option **E**:
External operation via touch control; 3 optical keys: [⊖], [0], [⊕]
- Operating elements also accessible in various hazardous areas

Additional functionality

- Data backup function
The device configuration can be saved in the display module.
- Data comparison function
The device configuration saved in the display module can be compared to the current device configuration.
- Data transfer function
The transmitter configuration can be transmitted to another device using the display module.

Via remote display and operating module FHX50

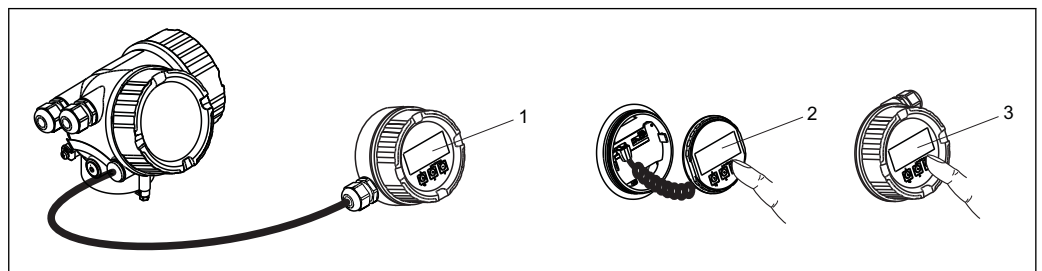

30 Operating options via FHX50

- 1 Housing of remote display and operating module FHX50
- 2 SD02 display and operating module, push buttons: cover must be opened for operation
- 3 SD03 display and operating module, optical buttons: operation possible through cover glass

Remote operation

Via HART protocol

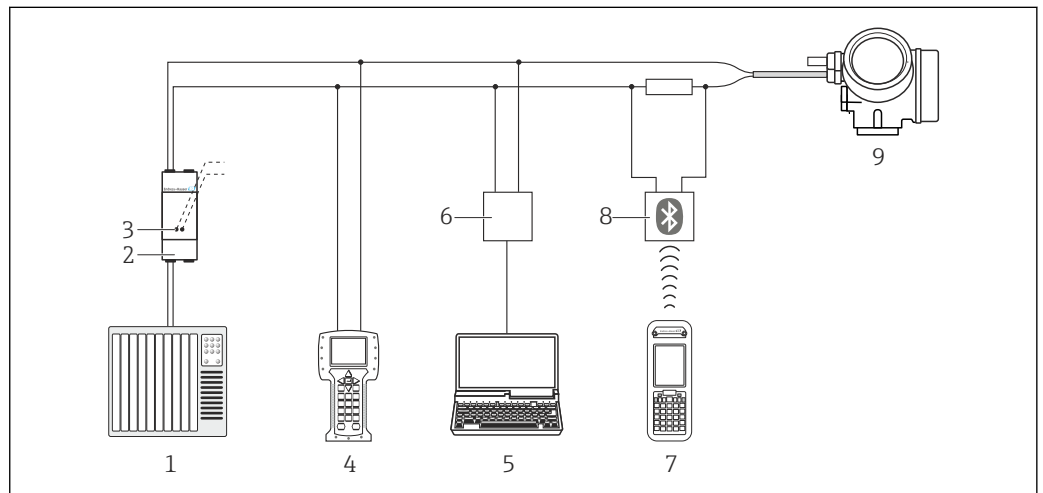

31 Options for remote operation via HART protocol

- 1 Control system (e.g. PLC)
- 2 Transmitter power supply unit, e.g. RN221N (with communication resistor)
- 3 Connection for Commubox FXA195 and Field Communicator 475
- 4 Field Communicator 475
- 5 Computer with operating tool (e.g. FieldCare, AMS Device Manager, SIMATIC PDM)
- 6 Commubox FXA195 (USB)
- 7 Field Xpert SFX350 or SFX370
- 8 VIATOR Bluetooth modem with connecting cable
- 9 Transmitter

Via FOUNDATION Fieldbus network

This communication interface is present in the following device version:
Order code for "Output", option **E**: FOUNDATION Fieldbus

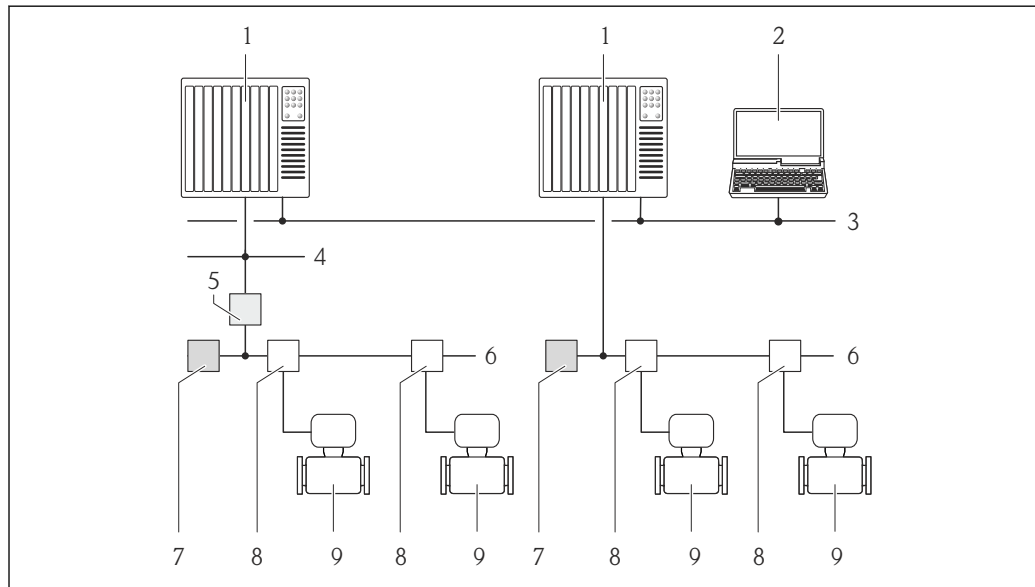

A0023460

- 1 Automation system
- 2 Computer with FOUNDATION Fieldbus network card
- 3 Industry network
- 4 High Speed Ethernet FF-HSE network
- 5 Segment coupler FF-HSE/FF-H1
- 6 FOUNDATION Fieldbus FF-H1 network
- 7 Power supply FF-H1 network
- 8 T-box
- 9 Measuring device

Via PROFIBUS PA network

This communication interface is present in the following device version:
Order code for "Output", option **G**: PROFIBUS PA

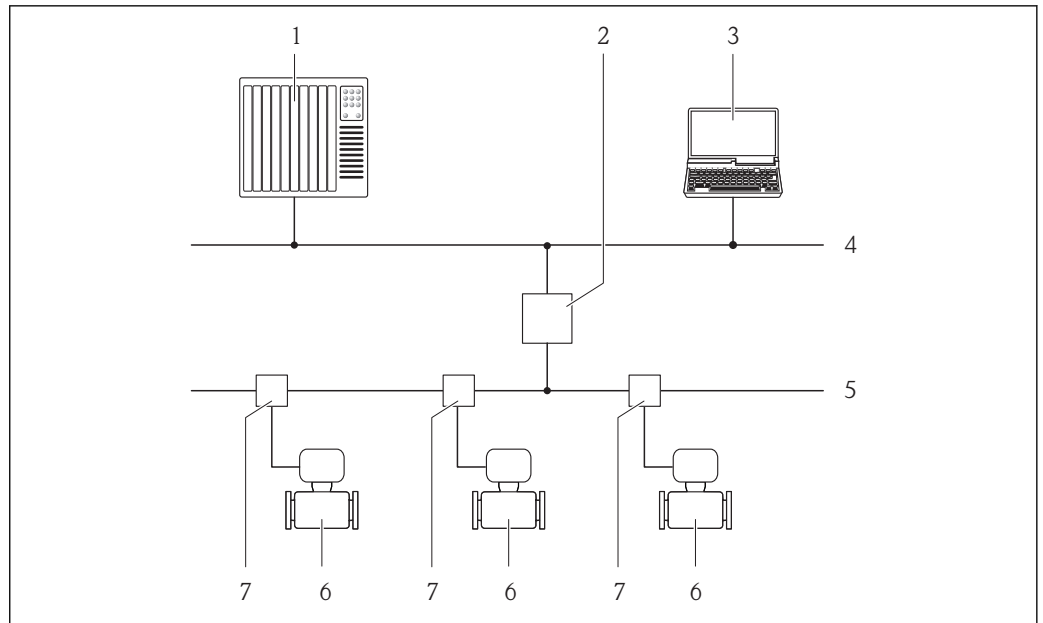

A0019013

- 1 Automation system
- 2 Segment coupler PROFIBUS DP/PA
- 3 Computer with PROFIBUS network card
- 4 PROFIBUS DP network
- 5 PROFIBUS PA network
- 6 Measuring device
- 7 T-box

Service interface

Service interface (CDI)

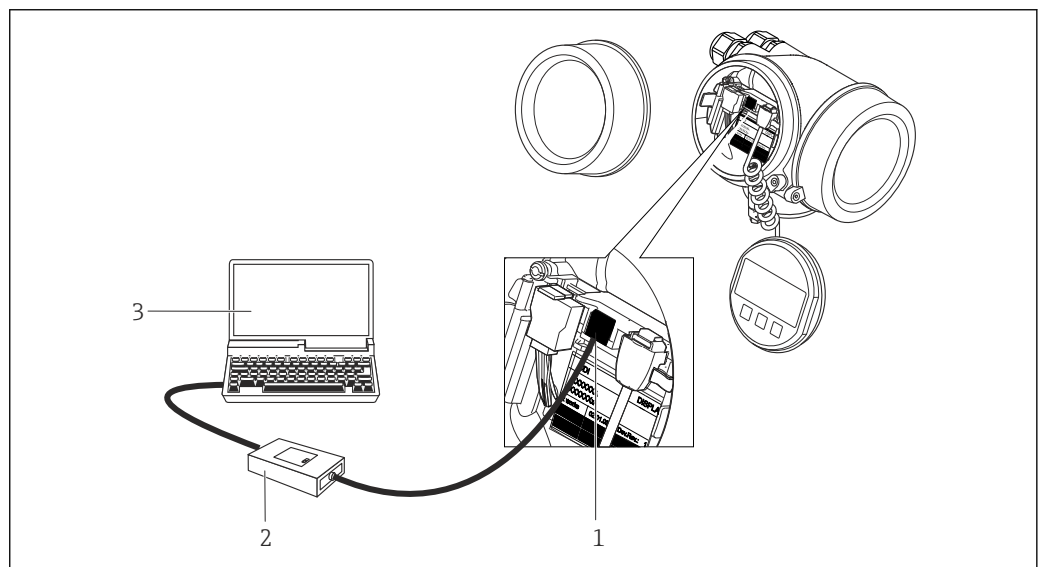

A0020545

- 1 Service interface (CDI = Endress+Hauser Common Data Interface) of the measuring device
- 2 Commubox FXA291
- 3 Computer with "FieldCare" operating tool with COM DTM "CDI Communication FXA291"

Certificates and approvals

CE mark

The measuring system is in conformity with the statutory requirements of the applicable EC Directives. These are listed in the corresponding EC Declaration of Conformity along with the standards applied.

Endress+Hauser confirms successful testing of the device by affixing to it the CE mark.

C-Tick symbol

The measuring system meets the EMC requirements of the "Australian Communications and Media Authority (ACMA)".

Ex approval

The measuring device is certified for use in hazardous areas and the relevant safety instructions are provided in the separate "Safety Instructions" (XA) document. Reference is made to this document on the nameplate.



The separate Ex documentation (XA) containing all the relevant explosion protection data is available from your Endress+Hauser sales center.

ATEX, IECEX

Currently, the following versions for use in hazardous areas are available:

Ex d

Category	Type of protection
II2G/Zone 1	Ex d[ia] IIC T6...T1
II1/2G/Zone 0/1	Ex d[ia] IIC T6...T1

Ex ia

Category	Type of protection
II2G/Zone 1	Ex ia IIC T6...T1
II1G/Zone 0	Ex ia IIC T6...T1
II1/2G/Zone 0/1	Ex ia IIC T6...T1

Ex ic

Category	Type of protection
II3G/Zone 2	Ex ic IIC T6...T1
II1/3G/Zone 0/2	Ex ic[ia] IIC T6...T1

Ex nA

Category	Type of protection
II3G/Zone 2	Ex nA IIC T6...T1

Ex tb

Category	Type of protection
II2D/Zone 21	Ex tb IIIC Txxx

cCSAus

Currently, the following versions for use in hazardous areas are available:

XP

Category	Type of protection
Class I, II, III Division 1 Groups A-G	XP (Ex d Flameproof version)

IS

Category	Type of protection
Class I, II, III Division 1 Groups A-G	IS (Ex i Intrinsically safe version)

NI

Category	Type of protection
Class I Division 2 Groups ABCD	NI (Non-incentive version), NIFW-Parameter*

*= Entity- und NIFW-Parameter gemäß Control Drawings

NEPSI

Currently, the following versions for use in hazardous areas are available:

Ex d

Category	Type of protection
Zone 1	Ex d ia IIC T1 ~ T6 Ex d ia Ga IIC T1 ~ T6
Zone 0/1	Ex d ia IIC T1 ~ T6 DIP A21 Ex d ia Ga IIC T1 ~ T6 DIP A21

Ex ia

Category	Type of protection
Zone 1	Ex ia IIC T1 ~ T6
Zone 0/1	Ex ia IIC T1 ~ T6 DIP A21

Ex ic

Category	Type of protection
IIG/Zone 2	Ex ic IIC T1 ~ T6
III1/3G/Zone 0/2	Ex ic ia Ga IIC T1 ~ T6

Ex nA

Category	Type of protection
Zone 2	Ex nA IIC T1 ~ T6 Ex nA ia Ga IIC T1 ~ T6

INMETRO

Currently, the following versions for use in hazardous areas are available:

Ex d

Category	Type of protection
-	Ex d ia IIC T6...T1

Ex ia

Category	Type of protection
-	Ex ia IIC T6...T1

Ex nA

Category	Type of protection
-	Ex nA IIC T6...T1 Ex nA ia Ga IIC T6...T1

Functional safety

The measuring device can be used for flow monitoring systems (min., max., range) up to SIL 2 (single-channel architecture) and SIL 3 (multichannel architecture with homogeneous redundancy) and is independently evaluated and certified by the TÜV in accordance with IEC 61508.

The following types of monitoring in safety equipment are possible:

Volume flow



Functional Safety Manual with information on the SIL device (→ 95)

FOUNDATION Fieldbus certification**FOUNDATION Fieldbus interface**

The measuring device is certified and registered by the Fieldbus FOUNDATION. The measuring system meets all the requirements of the following specifications:

- Certified in accordance with FOUNDATION Fieldbus H1
- Interoperability Test Kit (ITK), revision version 6.1.1 (certificate available on request)
- Physical Layer Conformance Test
- The device can also be operated with certified devices of other manufacturers (interoperability)

Certification PROFIBUS**PROFIBUS interface**

The measuring device is certified and registered by the PROFIBUS User Organization (PNO). The measuring system meets all the requirements of the following specifications:

- Certified in accordance with PROFIBUS PA Profile 3.02
- The device can also be operated with certified devices of other manufacturers (interoperability)

Pressure Equipment Directive

- With the PED/G1/x (x = category) marking on the sensor nameplate, Endress+Hauser confirms compliance with the "Essential Safety Requirements" specified in Annex I of the Pressure Equipment Directive 97/23/EC.
- Devices bearing this marking (PED) are suitable for the following types of medium: Media in Group 1 and 2 with a vapor pressure greater than, or smaller and equal to 0.5 bar (7.3 psi)
- Devices not bearing this marking (PED) are designed and manufactured according to good engineering practice. They meet the requirements of Art.3 Section 3 of the Pressure Equipment Directive 97/23/EC. The range of application is indicated in tables 6 to 9 in Annex II of the Pressure Equipment Directive.

Other standards and guidelines

- EN 60529
Degrees of protection provided by enclosures (IP code)
- DIN ISO 13359
Measurement of conductive liquid flow in closed conduits - Flanged-type electromagnetic flowmeters - Overall length
- EN 61010-1
Safety requirements for electrical equipment for measurement, control and laboratory use
- IEC/EN 61326
Emission in accordance with Class A requirements. Electromagnetic compatibility (EMC requirements).
- NAMUR NE 21
Electromagnetic compatibility (EMC) of industrial process and laboratory control equipment
- NAMUR NE 32
Data retention in the event of a power failure in field and control instruments with microprocessors
- NAMUR NE 43
Standardization of the signal level for the breakdown information of digital transmitters with analog output signal.
- NAMUR NE 53
Software of field devices and signal-processing devices with digital electronics
- NAMUR NE 105
Specifications for integrating fieldbus devices in engineering tools for field devices

- NAMUR NE 107
Self-monitoring and diagnosis of field devices
- NAMUR NE 131
Requirements for field devices for standard applications
- ASME BPVC Section VIII, Division 1
Rules for Construction of Pressure Vessels

Ordering information

Detailed ordering information is available from the following sources:

- In the Product Configurator on the Endress+Hauser web site: www.endress.com → Choose your country → Products → Select measuring technology, software or components → Select product (picklists: measurement method, product family etc.) → Device support (right-hand column): Configure the selected product → The Product Configurator for the selected product is opened.
- From your Endress+Hauser Sales Center: www.addresses.endress.com



Product Configurator - the tool for individual product configuration

- Up-to-the-minute configuration data
- Depending on the device: Direct input of measuring point-specific information such as measuring range or operating language
- Automatic verification of exclusion criteria
- Automatic creation of the order code and its breakdown in PDF or Excel output format
- Ability to order directly in the Endress+Hauser Online Shop

Application packages

Many different application packages are available to enhance the functionality of the device. Such packages might be needed to address safety aspects or specific application requirements.

The application packages can be ordered from Endress+Hauser either directly with the device or subsequently. Detailed information on the order code in question is available from your local Endress+Hauser sales center or on the product page of the Endress+Hauser website: www.endress.com.



Detailed information on the application packages:
Special Documentation on the device (→ 96)

Diagnostics functions	Package	Description
	HistoROM extended function	<p>Comprises extended functions concerning the event log and the activation of the measured value memory.</p> <p>Event log: Memory volume is extended from 20 message entries (basic version) to up to 100 entries.</p> <p>Data logging (line recorder):</p> <ul style="list-style-type: none"> ■ Memory capacity for up to 1000 measured values is activated. ■ 250 measured values can be output via each of the 4 memory channels. The recording interval can be defined and configured by the user. ■ Data logging is visualized via the local display or FieldCare.
Heartbeat Technology	Package	Description
	Heartbeat Verification	<p>Heartbeat Verification: Makes it possible to check the device functionality on demand when the device is installed, without having to interrupt the process.</p> <ul style="list-style-type: none"> ■ Access via onsite operation or other operating interfaces, such as FieldCare for instance. ■ Documentation of device functionality within the framework of manufacturer specifications, for proof testing for instance. ■ End-to-end, traceable documentation of the verification results, including report. ■ Makes it possible to extend calibration intervals in accordance with operator's risk assessment.

Air and industrial gases	Package	Description
	Air and industrial gases	<p>This application package enables users to calculate the density and energy of air and industrial gases. The calculations are based on time-tested standard calculation methods. It is possible to automatically compensate for the effect of pressure and temperature via an external or constant value.</p> <p>With this application package it is possible to output the energy flow, standard volume flow and mass flow of the following fluids:</p> <ul style="list-style-type: none"> ▪ Air ▪ Single gas ▪ Gas mixture ▪ User-specific gas

Wet steam detection	Package	Description
	Wet steam detection	<p>Wet steam detection provides a qualitative parameter for monitoring the steam application. It is an additional indicator for checking steam quality. A warning is displayed as soon as the steam quality drops below $x = 0.80$ (80%).</p> <ul style="list-style-type: none"> ▪ Additional quality parameter for ensuring a safe and efficient steam process ▪ Additional indicator to monitor the operation of steam traps

Natural gas	Package	Description
	Natural gas	<p>This application package enables users to calculate the chemical properties (gross calorific value, net calorific value) of natural gases. The calculations are based on time-tested standard calculation methods. It is possible to automatically compensate for the effect of pressure and temperature via an external or constant value.</p> <p>With this application package it is possible to output the energy flow, standard volume flow and mass flow based on the following standard methods:</p> <p>Energy can be calculated based on the following standards:</p> <ul style="list-style-type: none"> ▪ AGA5 ▪ ISO 6976 ▪ GPA 2172 <p>Density can be calculated based on the following standards:</p> <ul style="list-style-type: none"> ▪ ISO 12213-2 (AGA8-DC92) ▪ ISO 12213-3 ▪ AGA NX19 ▪ AGA8 Gross 1 ▪ SGERG 88







Accessories

Various accessories, which can be ordered with the device or subsequently from Endress+Hauser, are available for the device. Detailed information on the order code in question is available from your local Endress+Hauser sales center or on the product page of the Endress+Hauser website: www.endress.com.

Device-specific accessories

For the transmitter

Accessories	Description
Prowirl 200 transmitter	<p>Transmitter for replacement or for stock. Use the order code to define the following specifications:</p> <ul style="list-style-type: none"> ▪ Approvals ▪ Output ▪ Display / operation ▪ Housing ▪ Software <p> For details, see Installation Instructions EA01056D</p>







<p>Remote display FHX50</p>	<p>FHX50 housing to accommodate a display module (→  85).</p> <ul style="list-style-type: none"> ▪ FHX50 housing suitable for: <ul style="list-style-type: none"> – SD02 display module (push buttons) – SD03 display module (touch control) ▪ Housing material: <ul style="list-style-type: none"> – Plastic PBT – 316L ▪ Length of connecting cable: up to max. 60 m (196 ft) (cable lengths available for order: 5 m (16 ft), 10 m (32 ft), 20 m (65 ft), 30 m (98 ft)) <p>The measuring device can be ordered with the FHX50 housing and a display module. The following options must be selected in the separate order codes:</p> <ul style="list-style-type: none"> ▪ Order code for measuring device, feature 030: Option L or M "Prepared for FHX50 display" ▪ Order code for FHX50 housing, feature 050 (device version): Option A "Prepared for FHX50 display" ▪ Order code for FHX50 housing, depends on the desired display module in feature 020 (display, operation): <ul style="list-style-type: none"> – Option C: for an SD02 display module (push buttons) – Option E: for an SD03 display module (touch control) <p>The FHX50 housing can also be ordered as a retrofit kit. The measuring device display module is used in the FHX50 housing. The following options must be selected in the order code for the FHX50 housing:</p> <ul style="list-style-type: none"> ▪ Feature 050 (measuring device version): option B "Not prepared for FHX50 display" ▪ Feature 020 (display, operation): option A "None, existing displayed used" <p> For details, see Special Documentation SD01007F</p>
<p>Overvoltage protection for 2-wire devices</p>	<p>Ideally, the overvoltage protection module should be ordered directly with the device. See product structure, characteristic 610 "Accessory mounted", option NA "Overvoltage protection". Separate order necessary only if retrofitting.</p> <ul style="list-style-type: none"> ▪ OVP10: For 1-channel devices (characteristic 020, option A): ▪ OVP20: For 2-channel devices (characteristic 020, options B, C, E or G) <p> For details, see Special Documentation SD01090F.</p>
<p>Weather protection cover</p>	<p>Is used to protect the measuring device from the effects of the weather: e.g. rainwater, excess heating from direct sunlight or extreme cold in winter.</p> <p> For details, see Special Documentation SD00333F</p>
<p>Connecting cable for remote version</p>	<ul style="list-style-type: none"> ▪ Connecting cable available in various lengths: <ul style="list-style-type: none"> – 5 m (16 ft) – 10 m (32 ft) – 20 m (65 ft) – 30 m (98 ft) ▪ Reinforced cables available on request. <p> Standard length: 5 m (16 ft) Is always supplied if no other cable length has been ordered.</p>
<p>Post mounting kit</p>	<p>Post mounting kit for transmitter.</p> <p> The post mounting kit can only be ordered together with a transmitter.</p>

For the sensor

Accessories	Description
Flow conditioner	Is used to shorten the necessary inlet run.

Communication-specific accessories





Accessories	Description
Commubox FXA195 HART	<p>For intrinsically safe HART communication with FieldCare via the USB interface.</p> <p> For details, see "Technical Information" TI00404F</p>

Commubox FXA291	Connects Endress+Hauser field devices with a CDI interface (= Endress+Hauser Common Data Interface) and the USB port of a computer or laptop.  For details, see the "Technical Information" document TI405C/07
HART Loop Converter HMX50	Is used to evaluate and convert dynamic HART process variables to analog current signals or limit values.  For details, see "Technical Information" TI00429F and Operating Instructions BA00371F
Wireless HART adapter SWA70	Is used for the wireless connection of field devices. The WirelessHART adapter can be easily integrated into field devices and existing infrastructures, offers data protection and transmission safety and can be operated in parallel with other wireless networks with minimum cabling complexity.  For details, see Operating Instructions BA00061S
Fieldgate FXA320	Gateway for the remote monitoring of connected 4-20 mA measuring devices via a Web browser.  For details, see "Technical Information" TI00025S and Operating Instructions BA00053S
Fieldgate FXA520	Gateway for the remote diagnostics and remote configuration of connected HART measuring devices via a Web browser.  For details, see "Technical Information" TI00025S and Operating Instructions BA00051S
Field Xpert SFX350	Field Xpert SFX350 is a mobile computer for commissioning and maintenance. It enables efficient device configuration and diagnostics for HART and FOUNDATION Fieldbus devices in the non-Ex area .  For details, see Operating Instructions BA01202S
Field Xpert SFX370	Field Xpert SFX370 is a mobile computer for commissioning and maintenance. It enables efficient device configuration and diagnostics for HART and FOUNDATION Fieldbus devices in the non-Ex area and the Ex area .  For details, see Operating Instructions BA01202S

Service-specific accessories

Accessories	Description
Applicator	Software for selecting and sizing Endress+Hauser measuring devices: <ul style="list-style-type: none"> Calculation of all the necessary data for identifying the optimum flowmeter: e.g. nominal diameter, pressure loss, accuracy or process connections. Graphic illustration of the calculation results Administration, documentation and access to all project-related data and parameters over the entire life cycle of a project. Applicator is available: <ul style="list-style-type: none"> Via the Internet: https://wapps.endress.com/applicator On CD-ROM for local PC installation.
W@M	Life cycle management for your plant W@M supports you with a wide range of software applications over the entire process: from planning and procurement, to the installation, commissioning and operation of the measuring devices. All the relevant device information, such as the device status, spare parts and device-specific documentation, is available for every device over the entire life cycle. The application already contains the data of your Endress+Hauser device. Endress+Hauser also takes care of maintaining and updating the data records. W@M is available: <ul style="list-style-type: none"> Via the Internet: www.endress.com/lifecyclemanagement On CD-ROM for local PC installation.
FieldCare	FDT-based plant asset management tool from Endress+Hauser. It can configure all smart field units in your system and helps you manage them. By using the status information, it is also a simple but effective way of checking their status and condition.  For details, see Operating Instructions BA00027S and BA00059S

System components

Accessories	Description
Memograph M graphic display recorder	The Memograph M graphic display recorder provides information on all relevant measured variables. Measured values are recorded correctly, limit values are monitored and measuring points analyzed. The data are stored in the 256 MB internal memory and also on a SD card or USB stick.  For details, see "Technical Information" TI00133R and Operating Instructions BA00247R
RN221N	Active barrier with power supply for safe separation of 4-20 mA standard signal circuits. Offers bidirectional HART transmission.  For details, see "Technical Information" TI00073R and Operating Instructions BA00202R
RNS221	Supply unit for powering two 2-wire measuring devices solely in the non-Ex area. Bidirectional communication is possible via the HART communication jacks.  For details, see "Technical Information" TI00081R and Brief Operating Instructions KA00110R
Cerabar M	The pressure transmitter for measuring the absolute and gauge pressure of gases, steam and liquids. It can be used to read in the operating pressure value.  For details, see "Technical Information" TI00426P, TI00436P and Operating Instructions BA00200P, BA00382P
Cerabar S	The pressure transmitter for measuring the absolute and gauge pressure of gases, steam and liquids. It can be used to read in the operating pressure value.  For details, see "Technical Information" TI00383P and Operating Instructions BA00271P

Supplementary documentation

-  For an overview of the scope of the associated Technical Documentation, refer to the following:
- The CD-ROM provided for the device (depending on the device version, the CD-ROM might not be part of the delivery!)
 - The *W@M Device Viewer* : Enter the serial number from the nameplate (www.endress.com/deviceviewer)
 - The *Endress+Hauser Operations App*: Enter the serial number from the nameplate or scan the 2-D matrix code (QR code) on the nameplate.

Standard documentation

Brief Operating Instructions

Measuring device	Documentation code
Prowirl F 200	KA01136D

Operating Instructions

Measuring device	Documentation code		
	HART	FOUNDATION Fieldbus	PROFIBUS PA
Prowirl F 200	BA01154D	BA01217D	BA01222D

Supplementary device-dependent documentation

Safety Instructions

Contents	Documentation code
ATEX/IECEX Ex d, Ex tb	XA01148D
ATEX/IECEX Ex ia, Ex tb	XA01151D
ATEX/IECEX Ex ic, Ex nA	XA01152D
cCSA _{US} XP	XA01153D

Contents	Documentation code
cCSA _{US} IS	XA01154D
NEPSI Ex d	XA01238D
NEPSI Ex i	XA01239D
NEPSI Ex ic, Ex nA	XA01240D
INMETRO Ex d	XA01250D
INMETRO Ex i	XA01042D
INMETRO Ex nA	XA01043D

Special Documentation

Contents	Documentation code
Information on the Pressure Equipment Directive	SD01163D
Functional Safety Manual	SD01162D
Heartbeat Technology	SD01204D
Natural gas	SD01194D
Air + Industrial Gases (Single Gas + Gas Mixtures)	SD01195D
Wet steam detection	SD01193D
Inlet run correction	SD01226D

Installation Instructions

Contents	Documentation code
Installation Instructions for spare part sets	Specified for each individual accessory (→  92)

Registered trademarks

HART®

Registered trademark of the HART Communication Foundation, Austin, USA

PROFIBUS®

Registered trademark of the PROFIBUS User Organization, Karlsruhe, Germany

FOUNDATION™ Fieldbus

Registration-pending trademark of the Fieldbus Foundation, Austin, Texas, USA

KALREZ®, VITON®

Registered trademarks of DuPont Performance Elastomers L.L.C., Wilmington, DE USA

GYLON®

Registered trademark of Garlock Sealing Technologies, Palmyra, NY, USA

Applicator®, FieldCare®, Field Xpert™, HistoROM®, Heartbeat Technology™

Registered or registration-pending trademarks of the Endress+Hauser Group

www.addresses.endress.com
